

# Aspire 3300S

## Service Guide

Service guide files and updates are available on the AIPG/CSD web; for more information, please refer to <http://csd.acer.com.tw>

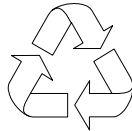

100% Recycled Paper

PART NO.: -----

PRINTED IN TAIWAN

---

# Revision History

Please refer to the table below for the updates made on Aspire 3300S service guide.

Date	Chapter	Updates

---

## Copyright

Copyright © 2002 by Acer Incorporated. All rights reserved. No part of this publication may be reproduced, transmitted, transcribed, stored in a retrieval system, or translated into any language or computer language, in any form or by any means, electronic, mechanical, magnetic, optical, chemical, manual or otherwise, without the prior written permission of Acer Incorporated.

## Disclaimer

The information in this guide is subject to change without notice.

Acer Incorporated makes no representations or warranties, either expressed or implied, with respect to the contents hereof and specifically disclaims any warranties of merchantability or fitness for any particular purpose. Any Acer Incorporated software described in this manual is sold or licensed "as is". Should the programs prove defective following their purchase, the buyer (and not Acer Incorporated, its distributor, or its dealer) assumes the entire cost of all necessary servicing, repair, and any incidental or consequential damages resulting from any defect in the software.

Acer is a registered trademark of Acer Corporation.

Intel is a registered trademark of Intel Corporation.

Pentium and Pentium 4 are trademarks of Intel Corporation.

Other brand and product names are trademarks and/or registered trademarks of their respective holders.

---

## Conventions

The following conventions are used in this manual:

Screen messages	Denotes actual messages that appear on screen.
<b>NOTE</b>	Gives bits and pieces of additional information related to the current topic.
<b>WARNING</b>	Alerts you to any damage that might result from doing or not doing specific actions.
<b>CAUTION</b>	Gives precautionary measures to avoid possible hardware or software problems.
<b>IMPORTANT</b>	Reminds you to do specific actions relevant to the accomplishment of procedures.

---

## Preface

Before using this information and the product it supports, please read the following general information.

1. This Service Guide provides you with all technical information relating to the BASIC CONFIGURATION decided for Acer's "global" product offering. To better fit local market requirements and enhance product competitiveness, your regional office MAY have decided to extend the functionality of a machine (e.g. add-on card, modem, or extra memory capability). These LOCALIZED FEATURES will NOT be covered in this generic service guide. In such cases, please contact your regional offices or the responsible personnel/channel to provide you with further technical details.
2. Please note WHEN ORDERING FRU PARTS, that you should check the most up-to-date information available on your regional web or channel. If, for whatever reason, a part number change is made, it will not be noted in the printed Service Guide. For ACER-AUTHORIZED SERVICE PROVIDERS, your Acer office may have a DIFFERENT part number code to those given in the FRU list of this printed Service Guide. You MUST use the list provided by your regional Acer office to order FRU parts for repair and service of customer machines.

---

Overview	1
Features	2
Front Panel Aspire 3300S	4
Rear Panel Aspire 3300S	6
System Block Diagram (Aspire 3300S)	8
Main Board Layout (Aspire 3300S)	10
Keyboard	12
Hardware Specifications and Configurations	14
Power Management Functions	22
Entering Setup	25
Product Information	27
Standard CMOS Features	29
Advanced BIOS Features	32
Advanced Chipset Features	34
Integrated Peripherals	36
Power Management Setup	38
PnP/PCI Configuration	40
PC Health Status	41
Frequency Control	42
Load Default Settings	43
Set Supervisor/User Password	44
Save & Exit Setup/Exit Without Saving	46
General Information	49
Disassembly Procedure Flowchart	50
Opening the Housing	51
Removing the Front Panel	52
Removing the EMI Audio Cover	52
Removing the Modem Card	53
Removing the AGP VGA Card	53
Removing the FDD and DVD Frame	53
Removing the Intrusion Alarm Cable	55
Removing the USB and Audio Board	56
Removing the Hard Disk Drive	56
Removing the DIMM	57
Removing the Power Supply	58
Removing the RTC Battery	58
Removing the Processor	59
Removing the Main board	60
Power-On Self-Test (POST)	63
POST Error Messages List	69
Error Symptoms List	71
Undetermined Problems	75
Aspire 3300S Exploded Diagram	89
Microsoft Windows XP Environment Test	99

# System Specifications

---

## Overview

The Aspire 3300S supports Intel® Pentium 4 (Willamette 478/Northwood) Flip Chip-Pin Grid Array 2 processor (FC-PGA2) based Micro ATX, IBM PC/AT compatible system with PCI/AGP bus.

---

# Features

## Performance

- Intel Pentium® IV processor with Intel NetBurst™ micro-architecture and integrated 256KB/512KB on-die L2 cache memory in Flip Chip 2 (FC)-mPGA 478 socket form factor, with supporting CPU clock up to 2.4GHz+.
- System Front Side bus speed:400 MHz.
- Maximum of 2GB DDR RAM within 2 DIMM sockets.
- Integrated LAN Controller.
- 3.5-inch and 5.25-inch floppy disk drives.
- CD-ROM/DVD-ROM /CD-RW drives
- 1x/2x/4x AGP slot
- High capacity, Enhanced-IDE hard disk
- Power management features
- CPU SMM (System Management Mode)
- Onboard PCI master enhanced local bus IDE (Embedded in 82801BA chipset).
  - PIO mode 4
  - Multiword DMA Mode 2
  - Ultra DMA/33, Ultra DMA/66 & Ultra DMA/100 modes
- Plug-and-Play (PnP) feature
- ACPI 1.0 b Compliant Power management and Configuration Support
- Software shutdown for Windows 95/98/ME/2000/XP
- Hardware monitor function

## Multimedia

- 128-bit graphics accelerator installed in the AGP Pro card slot
- An additional AGP card 1.5V slot, supports 2X and 4X
- Cathode-ray tube(CRT) support
- Liquid crystal display (LCD) support(optional)
- 3-D quality audio system via onboard audio controller
- Audio-in/Line-in, Audio-out/Line-out, Headphone-out, Mic-in, and Game/MIDI interface

**NOTE:** The system has dual RJ-11 phone jacks for line and phone on Modem card (option). One microphone jack and one speaker jack on FPIO board.

## Connectivity

- One AGP and three PCI slots
- One CNR slot
- USB and PS/2 compatible mouse and keyboard interfaces
- Two high-speed NS 16C550-compatible serial ports
- One multi-mode parallel port
- Four USB ports (available on front and rear panels) with Plug and Play function
- High-speed 56K V9.0 fax/data/voice PCI modem (optional)
- One RJ45 connector supports IEEE 802./802.3u 10Base-T/100Base-TX-compatible network with remote wake-up function



---

## **Expansion**

- 3 PCI slots + 2 DIMM slots + 1 AGP slot
- Upgradeable memory and hard disk







## **Human-centric design and ergonomics**

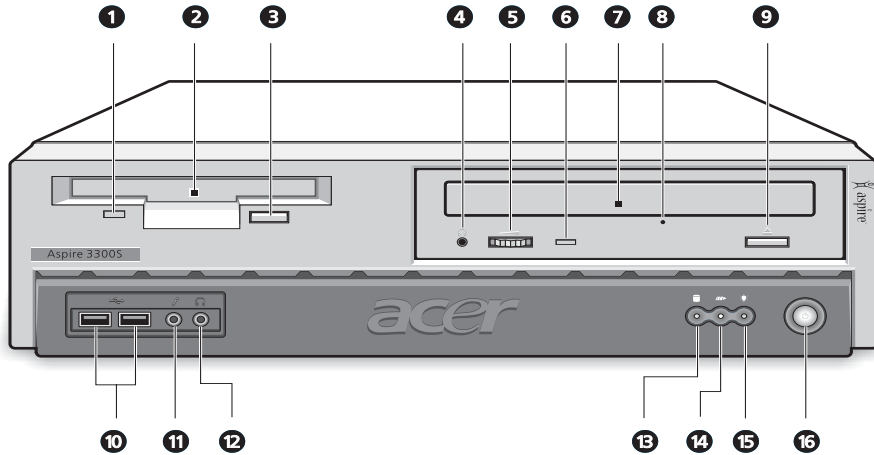



- Slim desktop form factor
- Separate computer stand and rubber stands for quick and easy positioning
- Accessible I/O ports
- Smooth and stylish design
- Low emission and low radiation

# Front Panel Aspire 3300S

The computer's front panel consists of the following:









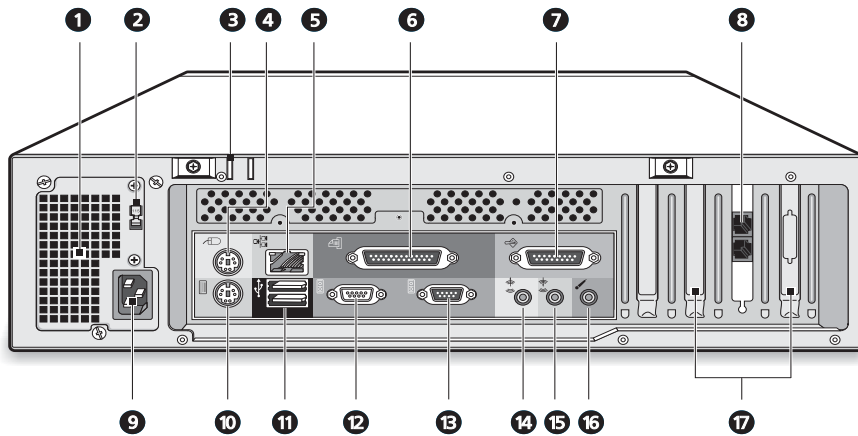

Label	Icon	Color	Description
1			Floppy drive light-emitting diode (LED)
2			3.5-inch floppy drive
3			Floppy drive eject button
4			CD-ROM/DVD-ROM/CD-RW Headphone/Earphone jack.
5			Volume control tuner
6			CD-ROM/DVD-ROM/CD-RW LED
7			CD-ROM/DVD-ROM/CD-RW tray
8			CD-ROM/DVD-ROM/CD-RW emergency eject hole
9			Stop/Eject button
10		Black	USB ports
11		Pink	Microphone-in port (front)*
12		Lime	Headphone-out port







Label	Icon	Color	Description
13			Hard disk drive activity LED
14			LAN Activity LED
15			Power LED
16			Power switch

**NOTE:** \*The system has two microphone-in ports (front and rear). However, you cannot use both of them at the same time. The default setting for your system enables the microphone-in port in front and disables the one at the back.

# Rear Panel Aspire 3300S



Label	Icon	Color	Description
1			Power supply
2			Voltage selector switch
3			Keyhole
4		Green	PS/2 mouse port
5		Gray	Network port
6		Burgundy	Parallel/Printer port
7		Gold	Game/MIDI port
8			VGA port*
9	 	Black	Handset/telephone line ports (optional)
10			Power cord socket

Label	Icon	Color	Description
11		Purple	PS/2 keyboard port
12		Black	USB ports
13		Teal or Turquoise	Serial port
14		Lime	Audio-out/Line-out jack
15		Light blue	Audio-in/Line-in jack
16			Microphone-in port (rear)**
17			Expansion slots

**NOTE:** \* The CRT monitor port is automatically disabled when an add-on VGA card is installed into the system. Connect the monitor to the VGA port instead.

\*\* The system has two microphone-in ports (front and rear). However, you can not use both of them at the same time. The default setting for your system enables the microphone-in port in front and disables the one at the back.

# System Block Diagram (Aspire 3300S)

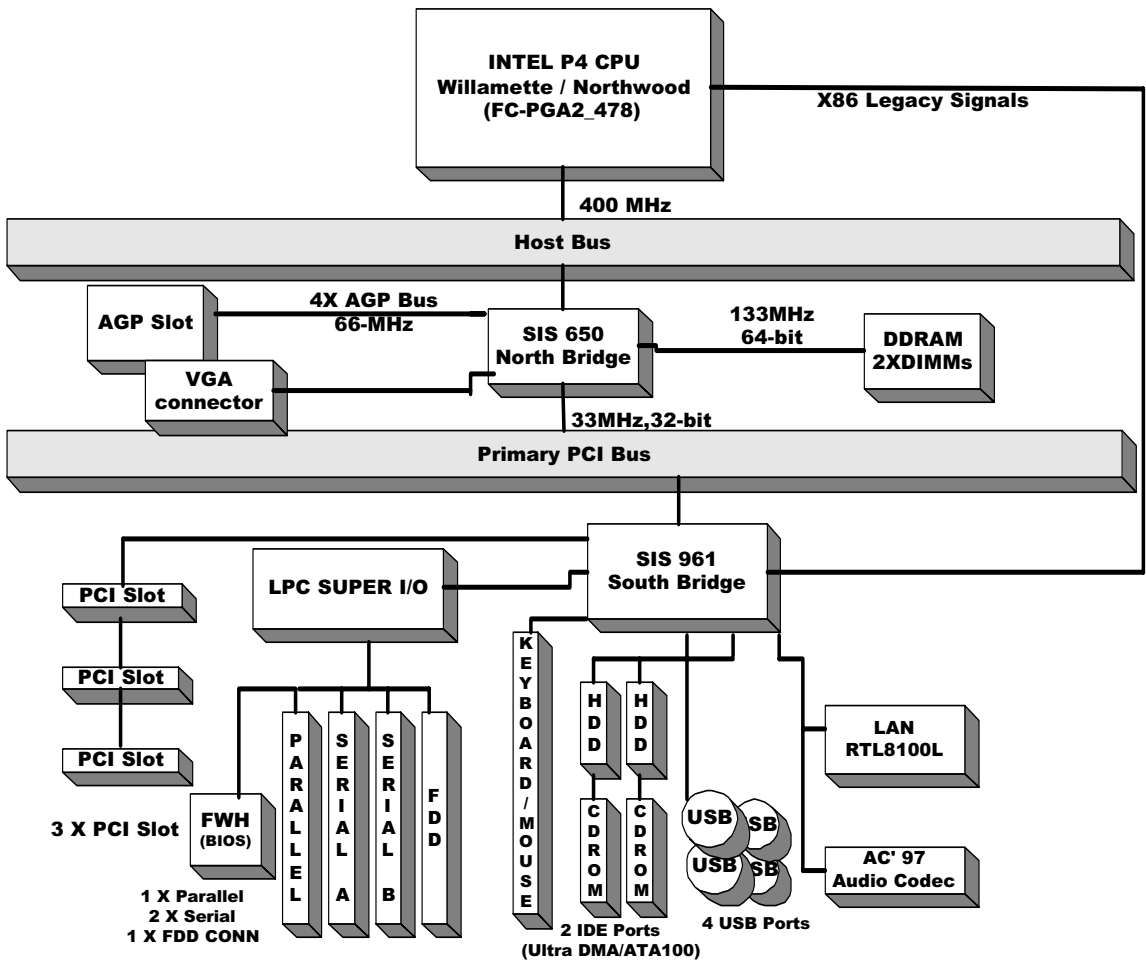



# Main Board Layout (Aspire 3300S)

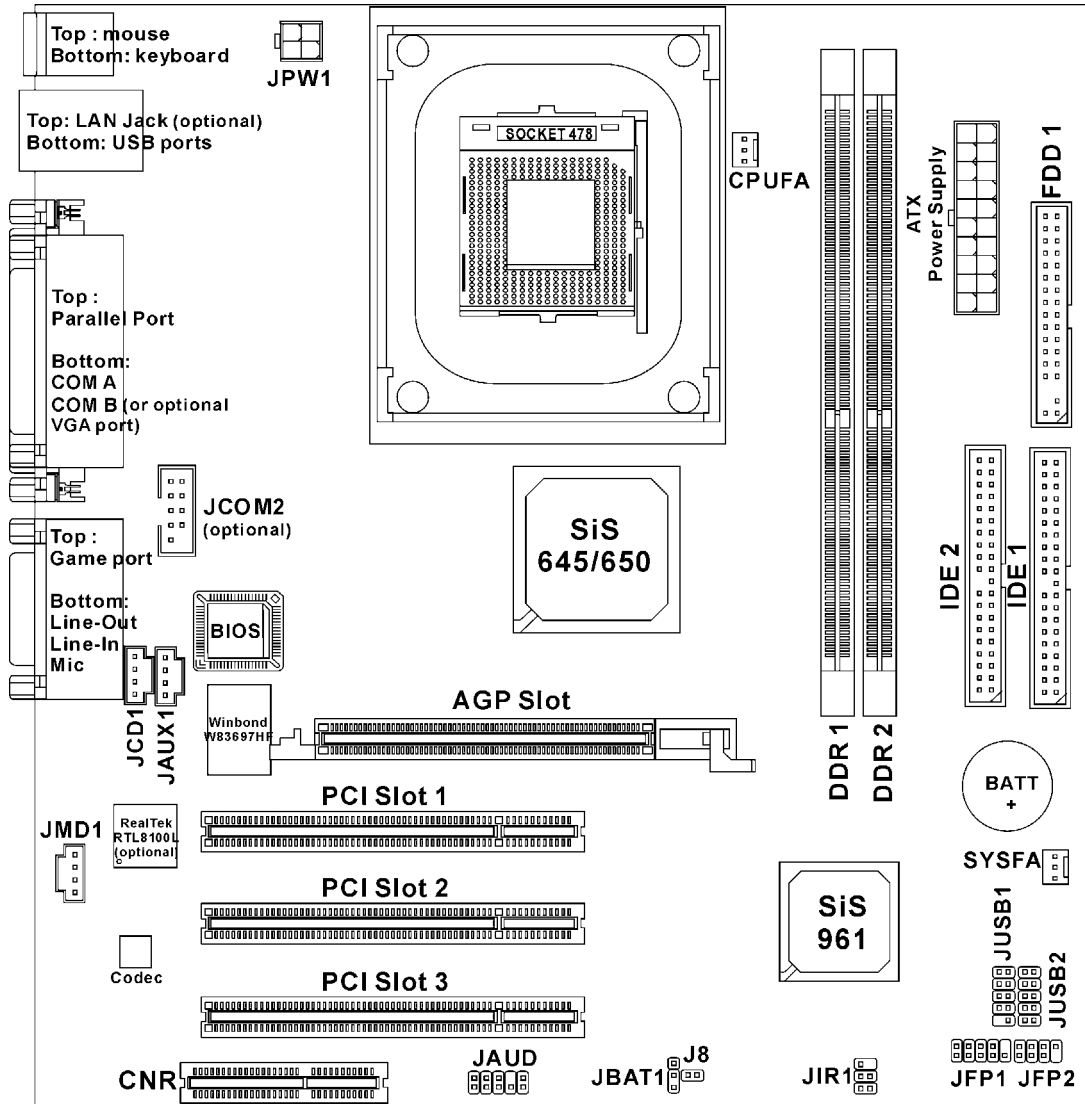

Component	Function
ATX Power Supply/JPW1	ATX power connectors
JKBMS1	Mouse/keyboard connector
USB Connectors	Connecting to USB devices
COM A & COM B	Serial port connector
VGA DB 15-pin	Connecting to VGA monitor
LAN Jack (optional)	Connecting to LAN devices
LPT1	Parallel port connector
FDD1	Floppy disk drive connector
J8	Chassis intrusion switch connector









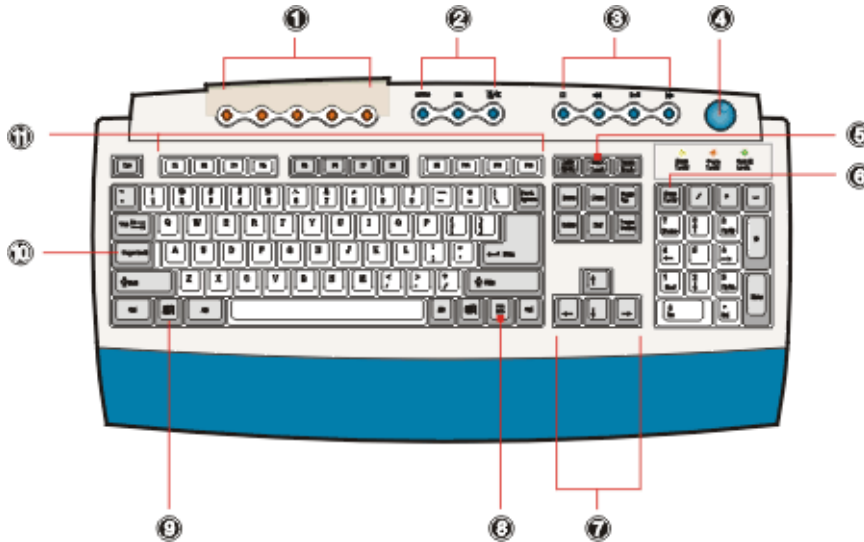

---





Component	Function
IDE 1~IDE 2	Hard disk connector
JCD1/JAUX1/JMD1	CD/AUX/Modem-in connectors
CPUFA/SYSFA	Fan power connectors
JFP1/JFP2	Front panel connectors
JAUD	Front panel audio connector
JUSB1/JUSB2	USB front connector
JIR1	IrDA infrared module connector
JBAT1	Clear CMOS jumper
AGP Slot	Connecting to AGP cards
PCI Slot	Connecting to expansion cards
CNR Slot	Connecting to expansion cards

# Keyboard

The keyboard has full-sized keys that include separate cursor keys, two Windows keys, and twelve function keys.



No.	Component	Description
1	Programmable keys	Help you directly access a URL (Web site) or launch any program, file, or application in your system. The fifth key is set to launch the media player. To configure the settings of each key, right-click on the Magic Keyboard icon located on your Windows desktop.
2	Internet/Suspend keys	Consist of three buttons: <ul style="list-style-type: none"> <li><b>Email</b>  : launches the email application that came bundled with your system.</li> <li><b>Web browser</b>  : launches the browser application that came bundled with your system.</li> <li><b>Suspend/Resume</b>  : puts the system to sleep when pressed. To wake up the system press it again.</li> </ul>
3	Multimedia keys	Allow you to do the following: <ul style="list-style-type: none"> <li><b>Play/Pause</b> button  : press to start playing the audio track or video file. Press again to pause.</li> <li><b>Stop</b> Button  : press to stop playing the audio track or video file.</li> <li><b>Forward</b> Button  : press to skip forward to the next track or file and start playing.</li> <li><b>Backward</b> button  : press to skip backward to the previous track or file and start playing.</li> </ul>

No.	Component	Description
4	Volume control/Mute knob 	Controls the speaker volume. Turn it clockwise or counterclockwise to adjust the volume. Press it to toggle between mute and sound.
5	Scroll Lock [	When activated, the screen moves one line up or down when you press the up arrow or down arrow respectively. Take note that [ may not work with some applications.
6	Num Lock ]	When activated, the keypad is set to numeric mode, i.e., the keys function as a calculator (complete with arithmetic operators such as +, -, * and /).
7	Cursor keys	Also called arrow keys, let you move the cursor around the screen. They serve the same function as the arrow keys on the numeric pad when the ] is toggled off.
8	Application key 	Opens the applications context menu (same function as clicking the right button of the mouse).
9	Windows logo key 	<b>Start</b> button. Combinations with this key perform special functions, such as: <ul style="list-style-type: none"> <li>• <b>Windows + Tab</b>: Activates the next Taskbar button</li> <li>• <b>Windows + E</b>: Explore My Computer</li> <li>• <b>Windows + F</b>: Find Document</li> <li>• <b>Windows + M</b>: Minimize All</li> <li>• <b>Shift + Windows + M</b>: Undo Minimize All</li> <li>• <b>Windows + R</b>: Displays Run dialog box</li> </ul>
10	Caps lock 	When activated, all alphabetic characters typed appear in uppercase (same function as pressing <b>j</b> + <letter>).
11	Function keys	Access most of the computer's controls like screen brightness, volume output and the BIOS utility.

---

# Hardware Specifications and Configurations

## Processor

Item	Specification
Type	Intel® Pentium IV processors with mPGA478 package
Slot	Socket mPGA478
Speed	Internal : 1.5~2.4GHz+ External: 400MHZ Data Bus Frequency
Minimum operating speed	0 MHz (If <b>Stop CPU Clock in Sleep State the BIOS Setup</b> is set to <b>Enabled.</b> )
Voltage	Processor voltage can be detected by the system without setting any jumper.

## BIOS

Item	Specification
BIOS code programmer	Award
BIOS version	V6.0
BIOS ROM size	2MB
Support protocol	PCI 2.1, APM1.2, DMI 2.00.1, E-IDE, ACPI 1.0, ESCD 1.03, ANSI ATA 3.0, PnP 1a, Bootable CD-ROM 1.0, ATAPI
Boot from CD-ROM feature	Yes
Support to LS-120 drive	No
Support to BIOS boot block feature	Yes

**NOTE:** The BIOS can be overwritten/upgraded using the FLASH utility (AWDFLASH.EXE).

## BIOS Hotkey List

Hotkey	Function	Description
	Enter BIOS Setup Utility	Press while the system is booting to enter BIOS Setup Utility.

This section has two table lists, system memory specification and the possible combinations of memory module.

### System Memory

Item	Specification
Memory socket number	2 slots (4 banks)
Support memory size per socket	64MB~1GB
Support maximum memory size	2GB
Support memory type	DDR SDRAM
Support memory speed	266MHz(PC2100)
Support memory voltage	2.5V
Support memory module package	184 -pin DIMM
Support to parity check feature	Yes
Support to Error Correction Code (ECC) feature.	Yes
Memory module combinations	You can install memory modules in any combination as long as they match the Memory Combination specifications.

### Memory Combinations

Slot	Memory Module	Total Memory
Slot 1 (Bank 0 & Bank 1)	64MB, 128MB, 256MB, 512MB, 1GB	64MB~1GB
Slot 2 (Bank 0 & Bank 1)	64MB, 128MB, 256MB, 512MB, 1GB	64MB~1GB
<b>Maximum System Memory Supported</b>		64MB~2GB

### Cache Memory

Item	
First-Level Cache Configurations	
Cache function control	Enable/Disable by BIOS Setup (Advanced options)
Second-Level Cache Configurations: Below information is only applicable to system with installed Pentium 4 processor.	
L2 Cache RAM size	Pentium IV processor: 256 KB
L2 Cache RAM speed	The same with the processor core clock frequency
L2 Cache function control	Enable/Disable by BIOS Setup

### Video Interface

Item	Specification
Video controller resident bus	AGP bus
Video interface support	1x / 2x / 4x AGP Signaling and 2x / 4x Fast Writes The AGP buffers operate only 1.5V mode

## Audio Interface

Item	Specification
Audio controller	SiS961
Audio controller resident bus	AC'97 link
Audio function control	Enable/disable by BIOS Setup
Mono or stereo	Stereo
Resolution	16 bits
Compatibility	AC'97 2.1 compliant Sound Blaster Pro compatible Mixed digital and analog high performance chip Enhanced stereo full duplex operation High performance PCI audio accelerator Full native DOS games compatibility High-Quality ESFM music synthesizer MPU-401(UART mode) interface for wavetable synthesizers and MIDI devices Integrated dual game port Meets PC 97/PC98 and WHQL specifications
Music synthesizer	Yes
Sampling rate	44.1 KHz
MPU-401 UART support	Yes
Microphone jack	Supported On audio-I/O board (connects via CN6)
Headphone jack	Supported On audio-I/O board (connects via CN6)

## IDE Interface

Item	Specification
IDE controller	SiS961
IDE controller resident bus	PCI bus
Number of IDE channel	2 onboard: 40-pin hard disk drive connector,
Support IDE interface	E-IDE (up to PIO mode 4 and Ultra DMA/33, Ultra DMA/66 and Ultra DMA/100 mode 2) ANSIS ATA rev.4.0 ATAPI
Support bootable CD-ROM	Yes

## Floppy disk drive Interface

Item	Specification
Floppy disk drive controller	LPC Super I/O
Floppy disk drive controller resident bus	LPC
Support FDD format	360KB, 720KB, 1.2MB, 1.44MB, 2.88MB; 3-mode

## Parallel Port

Item	Specification
Parallel port controller	LPC Super I/O
Parallel port controller resident bus	LPC
Number of parallel ports	1
Support ECP/EPP	SPP/ECP / EPP 1.7 & 1.9
Connector type	25-pin D-type female connector
Parallel port function control	Enable/disable by BIOS Setup
Optional ECP DMA channel (in BIOS Setup)	DMA channel 1 DMA channel 3
Optional parallel port I/O address (via BIOS Setup)	378h 278h
Optional parallel port IRQ (via BIOS Setup)	IRQ5 IRQ7

## Serial Port

Item	Specification
Serial port controller	LPC Super I/O
Serial port controller resident bus	LPC
Number of serial port	2
Serial ports location	COM1, COM 2
16550 UART support	Yes
Connector type	10-pin connector
Optional serial port I/O address (via BIOS Setup)	3F8h, 2F8h, 3E8h, 2E8h
Optional serial port IRQ (via BIOS Setup)	4, 3

## Modem

Item	Specification
Fax modem data baud rate (bps)	14.4K bps
Data modem data baud rate (bps)	56K bps
Voice modem	Yes
Modem connector type	Not Applicable
Full duplex	Not applicable

## USB Port

Items	Specifications
Universal HCI	USB 1.1
USB Class	Support legacy keyboard for legacy mode

## Memory Address Map

Address	Size	Function
000000 - 07FFFF	512KBytes	Host Memory
080000 - 09FFFF	128KBytes	Host/PCI Memory
0A0000 - 0BFFFF	128KBytes	PCI/ISA Video Buffer Memory
0C0000 - 0C7FFF	32KBytes	Video BIOS Memory
0C8000 - 0DFFFF	96KBytes	ISA Card BIOS & Buffer Memory
0E0000 - 0EFFFF	64KBytes	BIOS Extension Memory Setup and Post Memory PCI Development BIOS
0F0000 - 0FFFFF	64KBytes	System BIOS Memory
100000 - UPPER LIMIT		Main Memory
UPPER LIMIT - 4GBytes		PCI Memory

**Note :** UPPER LIMIT means the maximum size of installed memory.

The Main Memory Maximum size are 768M Bytes.

## Onboard Device ID & IRQ Map

Device	AD#	IDSEL	Route Reg.	Mask
Intel 845 MCH	AD11	00h		
P2P	AD30	13h		
(Func.0) ICH2 (LPC)	AD31	14h		
(Func.1) ICH2 (IDE)	AD31	14h		
(Func.2) ICH2 (USB)	AD31	14h	68h	FFh
(Func.3) ICH2 (SMBUS)	AD31	14h		
(Func.5) ICH2 (AC97 Audio)	AD31	14h	61h	FFh
PCI Slot 1	AD16	05h	60h	FFh
PCI Slot 2	AD17	06h	61h	FFh
PCI Slot 3	AD21	07h	62h	FFh

## PCI Slot IRQ Routing Map

PCI INTX#	INTA	INTB	INTC	INTD
PCI 1	Route 1	Route 2	Route 3	Route 4
PCI 2	Route 2	Route 3	Route 4	Route 1
PCI 3	Route 3	Route 4	Route 1	Route 2



## I/O Address Map

Hex Range	Devices
000-00F	DMA Controller-1
020-021	Interrupt Controller-1
040-043	System Timer
060-060	Keyboard Controller 8742
061-061	System Speaker
070-071	CMOS RAM Address and Real Time Clock
081-08F	DMA Controller-2
0A0-0A1	Interrupt Controller-2
0C0-0DF	DMA Controller-2
0F0-0FF	Math Co-Processor
170-177	Secondary IDE
1F0-1F7	Primary IDE
278-27F	Parallel Printer Port 2
2F8-2FF	Serial Asynchronous Port 2
378-37F	Parallel Printer Port 1
3F0-3F5	Floppy Disk Controller
3F6-3F6	Secondary IDE
3F7-3F7	Primary IDE
3F8-3FF	Serial Asynchronous Port 1
0CF8	Configuration Address Register
0CFC	Configuration Data Register
778-77A	Parallel Printer Port 1

## IRQ Assignment Map

IRQx	System Devices	Add-On-Card Devices
IRQ0	Timer	N (Notes)
IRQ1	Keyboard	N
IRQ2	Cascade Interrupt Control	N
IRQ3	Serial Alternate	Reserved
IRQ4	Serial Primary	Reserved
IRQ5	Parallel Port (Alternate)	Reserved
IRQ6	Floppy Diskette	Reserved
IRQ7	Parallel Port	Reserved
IRQ8	Real Time Clock	N
IRQ9	N	Reserved
IRQ10	N	Reserved
IRQ11	N	Reserved
IRQ12	PS/2 Mouse	Reserved
IRQ13	Math Co-processor Exception	N
IRQ14	Fix Diskette	Reserved
IRQ15	Fix Diskette	Reserved

**NOTE:** N - Not to be used.

## DRQ Assignment Map

DRQx	System Devices	Add-On-Card Devices
DRQ0	N (Notes)	Reserved
DRQ1	N	Reserved
DRQ2	Floppy Diskette	N
DRQ3	N	Reserved
DRQ4	Cascade	N
DRQ5	N	Reserved
DRQ6	N	Reserved
DRQ7	N	Reserved

**NOTE:** N - Not to be used.

## Main Board Major Chips

Item	Controller
North Bridge	SiS 650
South Bridge	SiS 961
Super I/O controller	ITE IT8705F
Audio controller	SiS961
LAN controller	SiS961
HDD controller	SiS961
Keyboard controller	SiS961
RTC	SiS961

## Environmental Requirements

Item	Specifications
<b>Temperature &amp; Humidity</b>	
Operating	+10 to +45°C
Non-operating	-10 to +60°C
Non-operating	-20 to +60°C (Storage package)
<b>Humidity</b>	
Operating	20% to 80% RH, non-condensing
Non-operating	20% to 80% RH, non-condensing (Unpacked)
Non-operating	20% to 80% RH, non-condensing (Storage package)
<b>Vibration</b>	
Operating	5~16.2Hz      0.388mm(peak to peak) 16.2~250Hz    0.2G
Sweep Rate	1 octave/minute
Direction	X,Y,Z axis
Test Cycles	2 cycles per axis
Non-operating (Packed)	5~27.1Hz      0.6G 27.1~50Hz     0.44mm(peak to peak) 50~500Hz      2.0G
Sweep rate	0.5 octave/minute
Direction	X,Y,Z axis
Test Cycles	4 cycles per axis

## Mechanical Specifications

Item	Specification
Weight One 3.5 FDD and one 3.5 HDD (without packing)	Depends on local configuration

## Switching Power Supply

Input Frequency	Frequency Variation Range
50Hz	47Hz to 53Hz
60Hz	57Hz to 63Hz

Input Voltage	Variation Range
100 - 120 VRMS	90-132 VRMS
200 - 240 VRMS	180-264 VRMS

Input Current	Measuring Range
3A	180 - 264 VRMS

(This is for 160W power supply)

Output Requirements	Regulation	Current Rating(Max)
+5V	+5%	8A
+12V	+5%	8A
-12V	+10%	0.3A
+3.3	+5%	10A
-5V	+10%	0.2A
+5V	+5%	3A

**NOTE:** 1. +3.3V and +5V total output power can't exceed 80W.

---

# Power Management Functions

## Device Standby Mode

- Independent power management timer for hard disk drive devices (0-15 minutes, time step=1 minute).
- Hard disk drive goes into Standby mode (for ATA standard interface).
- Disable V-sync to control the VESA DPMS monitor.
- Resume method: device activated (Keyboard for DOS, keyboard & mouse for Windows).
- Resume recovery time: 3-5 sec.

## Global Standby Mode

- Global power management timer (2-120 minutes, time step=10 minute).
- Hard disk drive goes into Standby mode (for ATA standard interface).
- Disable H-sync and V-sync signals to control the VESA DPMS monitor.
- Resume recovery time: 7-10 sec.

## Suspend Mode

- Independent power management timer (2-120 minutes, time step=10 minutes) or pushing external switch button
- CPU goes into SMM.
- CPU asserts STPCLK# and goes into the Stop Grant State.
- LED on the panel turns amber color.
- Hard disk drive goes into SLEEP mode (for ATA standard interface).
- Disable H-sync and V-sync signals to control the VESA DPMS monitor.
- Return to original state by pushing external switch button.

## Suspend to RAM

- The system context is maintained in system memory
- Power is shut to non-critical circuits.
- Memory is retained, and refreshes continually.
- All clocks shut except RTC.
- Return to original state by pushing external switch button & "PME" events at ACPI mode.



## System Utilities

---

Most systems are already configured by the manufacturer or the dealer. There is no need to run Setup when starting the computer unless you get a Run Setup message.

The Setup program loads configuration values into the battery-backed nonvolatile memory called CMOS RAM. This memory area is not part of the system RAM.

**NOTE:** If you repeatedly receive Run Setup messages, the battery may be bad/flat. In this case, the system cannot retain configuration values in CMOS.

Before you run Setup, make sure that you have saved all open files. The system reboots immediately after you exit Setup.

---

## Entering Setup

Power on the computer and the system will start POST (Power On Self Test) process. When the message of "Press DEL to enter SETUP" appears on the screen, press the key of [Delete] to enter the setup menu.





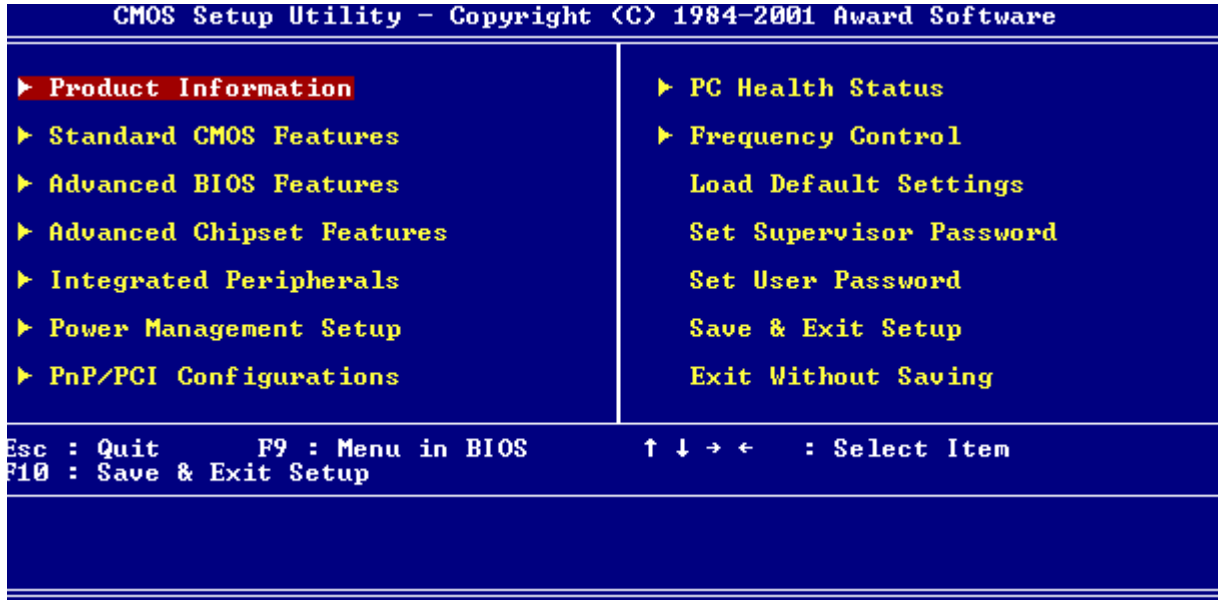

**NOTE:** If the message disappears before you respond and you still wish to enter Setup, restart the system by turning it OFF and On. You may also restart the system by simultaneously pressing [Ctrl+Alt+Delete].

The Setup Utility main menu then appears:



---

The command line at the bottom of the menu tells you how to move within a screen and from one screen to another.

- ❑ To select an option, move the highlight bar by pressing  or  then press .
- ❑ To change a parameter setting, press  or  until the desired setting is found.
- ❑ Press  to return to the main menu. If you are already in the main menu, press  again to exit Setup.

The parameters on the screens show default values. These values may not be the same as those in your system.

The grayed items on the screens have fixed settings and are not user-configurable.

**NOTE:** Due to the application of a new version of BIOS Setup program, you may find the BIOS menu is largely different from the former models. However, you will soon find out that this version is much more compact than the former ones.



# Product Information

The screen below appears if you select Product Information from the main menu:

The Product Information menu contains general data about the system, such as the product name, serial number, BIOS version, etc. This information is necessary for troubleshooting (maybe required when asking for technical support).

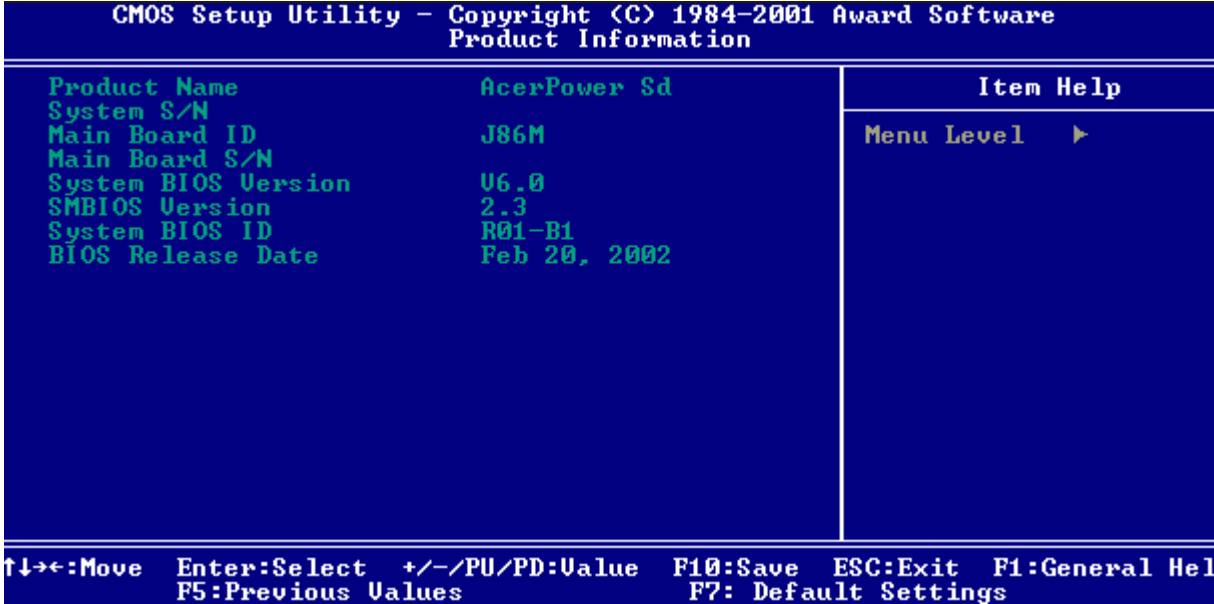

---

The following table describes the parameters found in this menu:

<b>Parameter</b>	<b>Description</b>
Product Name	Displays the model name of your system.
System S/N	Displays your system's serial number.
Main Board ID	Displays the main board's identification number.
Main Board S/N	Displays your main board's serial number.
System BIOS Version	Specifies the version of your BIOS utility.
SMBIOS version	The System Management Interface (SM) BIOS allows you to check your system hardware components without actually opening your system. Hardware checking is done via software during start up. This parameter specifies the version of the SMBIOS utility installed in your system.
System BIOS ID	Specifies the version ID of the BIOS utility.
BIOS Release Date	Displays the release date of the BIOS utility.

## Standard CMOS Features

Select Standard CMOS Features from the main menu to configure some basic parameters in your system.

The following screen shows the Standard CMOS Features menu:

```

CMOS Setup Utility - Copyright (C) 1984-2001 Award Software
Standard CMOS Features

Date (mm:dd:yy)      Tue, Feb 26 2002
Time (hh:mm:ss)     11 : 37 : 27

▶ IDE Primary Master
▶ IDE Primary Slave
▶ IDE Secondary Master
▶ IDE Secondary Slave

Drive A              [1.44M, 3.5 in.]
Drive B              [None]
Floppy 3 Mode Support [Disabled]

Video                [EGA/UGA]
Halt On              [All , But Keyboard]

Base Memory          640K
Extended Memory     65472K
Total Memory         1024K

Item Help
Menu Level ▶
Change the day, month,
year and century

↑↓←→:Move  Enter:Select  +/-/PU/PD:Value  F10:Save  ESC:Exit  F1:General Hel
F5:Previous Values  F7: Default Settings
  
```

The following table describes the parameters found in this menu. Settings in **boldface** are the default and suggested settings.

Parameter	Description	Options
Date	Lets you set the date following the weekday-month-day-year format	Weekday: Sun, Mon...Sat Month: Jan, Feb...Dec. Day: 1 to 30 Year: 1980 to 2079
Time	Lets you set the time following the hour-minute-second format	Hour: 0 to 23 Minute: 0 to 59 Second: 0 to 59
IDE Primary Channel Master	Allows you to configure the hard disk drive connected to the master port of IDE channel 1. To enter the IDE Primary Master setup, press [Enter]. The IDE CD-ROM is always automatically detected.	IDE Device Model Number: None
IDE Primary Channel Slave	Allows you to configure the hard disk drive connected to the slave port of IDE channel 1. To enter the IDE Primary Slave setup, press [Enter]. The IDE CD-ROM is always automatically detected.	IDE Device Model Number: None

Parameter	Description	Options
IDE Secondary Channel Master	Allows you to configure the hard disk drive connected to the master port of IDE channel 2. To enter the IDE Secondary Master setup, press [Enter]. The IDE CD-ROM is always automatically detected.	IDE Device Model Number: None
IDE Secondary Channel Slave	Allows you to configure the hard disk drive connected to the slave port of IDE channel 2. To enter the IDE Secondary Slave setup, press [Enter]. The IDE CD-ROM is always automatically detected.	IDE Device Model Number: None
Drive A	Allows you to configure your floppy drive A.	<b>1.44 MB, 3.5-inch</b> None 360 KB, 5.25-inch 1.2 MB, 5.25-inch 720 KB, 3.5-inch 2.88 MB, 3.5-inch
Drive B	Allows you to configure your floppy drive B.	1.44 MB, 3.5-inch <b>None</b> 360 KB, 5.25-inch 1.2 MB, 5.25-inch 720 KB, 3.5-inch 2.88 MB, 3.5-inch
Floppy 3 Mode Support	Floppy 3 is the standard Japanese floppy drive mode. Supported by the BIOS, the selected diskette drive can read 720KB, 1.2MB and 1.44MB on a 3.5" diskette.	<b>Disabled</b> , Enabled.
Video	This item specifies the type of video card in use. The default setting is VGA/EGA. Since current PCs use VGA only, this function is almost useless and may be disregarded in the future.	<b>VGA/EGA</b> CGA40 CGA80 Mono
Halt On	This parameter enables you to control the system stops in case of Power On Self Test errors (POST).	<b>All Errors</b> No Errors All but Keyboard All but Diskette All by Disk/Key
Base Memory	Refers to the option of memory that is available to standard DOS programs. DOS systems have an address space of 1MB, but the top 384KB (called high memory) is reserved for system use. This leaves 640 KB of conventional memory. Everything above 1MB is either extended or extended memory.	
Extended Memory	Memory above and beyond the standard 1MB of base memory that DOS supports. Extended memory is only available in PCs with an Intel 80286 or later microprocessor. Extended memory is not configured in any special manner and is therefore unavailable to most DOS programs. However, MS Windows and OS/2 can use extended memory.	
Total Memory	Total based and extended memory, and I/O ROM 384KB available to the system.	

## IDE Primary/Secondary Channel Master/Slave Setup

The following screen appears if you select any of the IDE drive parameters:

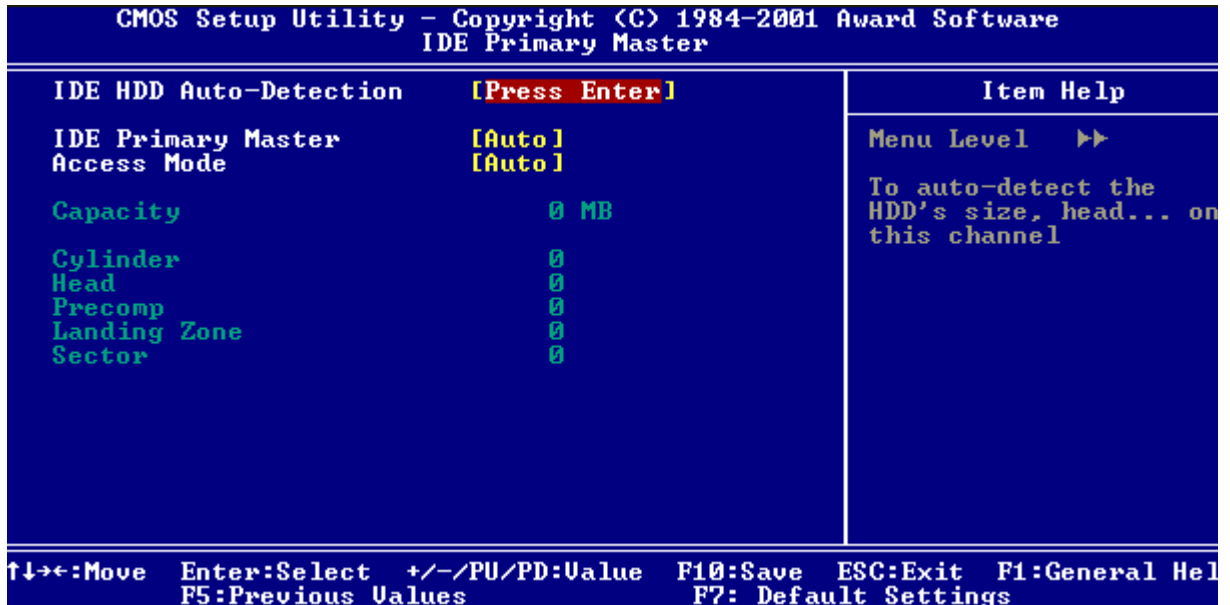

The following table describes the parameters found in this menu. Settings in **boldface** are the default and suggested settings.

Parameter	Description	Options
IDE HDD Auto-Detection	Auto-detects your hard disk drive	<b>Press [Enter]</b>
IDE Primary Master	Display the type of device installed.	<b>Auto</b> None Manual
Access Mode	Selects the HDD access mode	<b>Auto</b> Large LBA CHS
Capacity	Shows the size of your HDD in MB	xxxxx MB
Cylinder	Shows your hard disk's number of cylinders	0 to 65535
Head	Shows your hard disk's number of heads	0 to 255
Precomp	Selects the precomp number for old HDD parking	0 to 65535
Landing Zone	Selects the Land Zone number for old HDD parking	0 to 65535
Sector	Shows your hard disk's number of sectors	0 to 255

# Advanced BIOS Features

The following screen shows the Advanced BIOS Features:

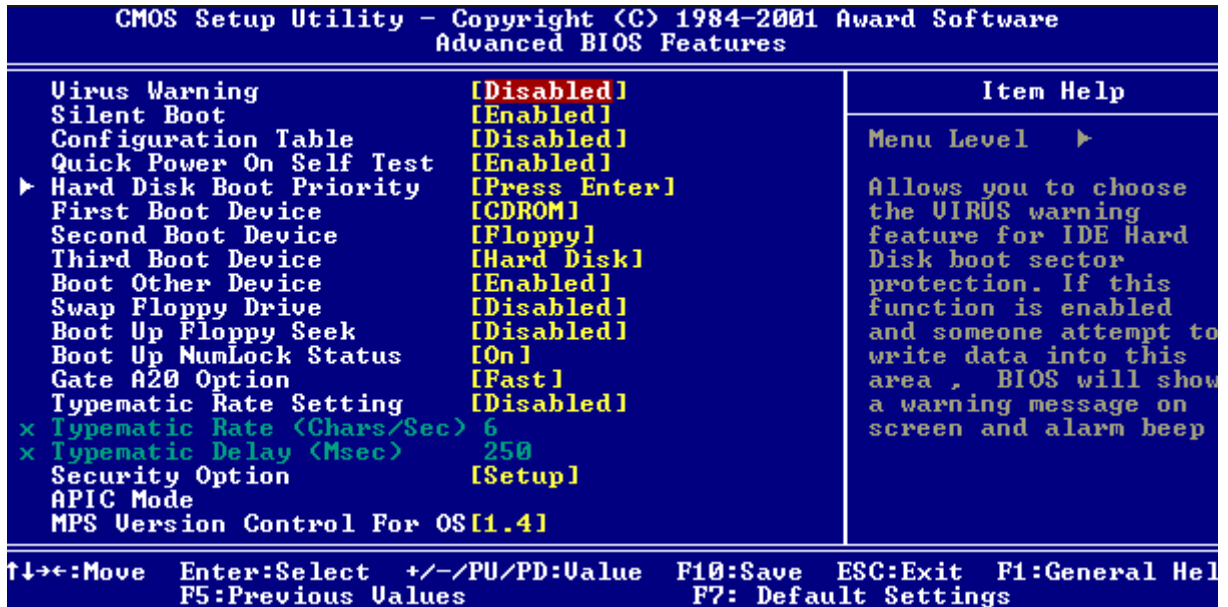

The following table describes the parameters found in this menu. Settings in **boldface** are the default and suggested settings.

Parameter	Description	Options
Virus Warning	Allows you to set the virus warning feature for IDE Hard Disk boot sector protection. If the function is enabled and any attempt to write data into this area is made, BIOS will display a warning message on screen and beep.	Enabled <b>Disabled</b>
Quick Power On Self Test	This parameter speeds up POST by skipping some items that are normally checked.	<b>Enabled</b> Disbaled
Hard Disk Boot Priority		
First/Second/Third Boot Device	The items allow you to set the sequence of boot device where BIOS attempts to load the disk operating system.	Floppy, LS120, HDD-0, SCSI, CDROM, HDD-1, HDD-2, HDD-3, ZIP, LAN, Disabled (Disable this sequence ). The sequence following the order of HDD, Floppy and CD-ROM is recommended.
Boot Other Device	This parameter allows you to specify the system boot up search sequence.	<b>Enabled</b> Disbaled
Swap Floppy Drive	Setting to Enabled will swap floppy drive a: and b:.	Enabled <b>Disabled</b>
Boot Up Floppy Seek	Setting to Enabled will make BIOS seek floppy drive a: before booting the system.	Enabled <b>Disabled</b>

Parameter	Description	Options
Boot Up NumLock Status	Sets the NumLock status when the system is powered on. Setting to On will turn on the NumLock key when the system is powered on. Setting to Off will allow users to use the arrow keys on the numeric keypad.	<b>On</b> Off
Gate A20 Option	This item is to set the Gate A20 status. A20 refers to the first 64KB of extended memory. When the default value Fast is selected, the Gate A20 is controlled by port 92 or chipset specific method resulting in faster system performance. When Normal is selected, A20 is controlled by a keyboard controller or chipset hardware.	<b>Fast</b> Normal
Typematic Rate Setting	This item is used to enable or disable the typematic rate setting including Typematic Rate and Typematic Delay.	Enabled <b>Disabled</b>
Typematic Rate	After Typematic Rate Setting is enabled, this item allows you to set the rate (characters/second) at which keys are accelerated.	Settings: 6,8,10,12,15,20,24 and 30.
Typematic Delay	This item allows you to select the delay between when the key was first pressed and when the acceleration begins	Settings: 250, 500, 750 and 1000.
Security Option	Specifies the type of BIOS password protection that is implemented. Setup means that the password prompt appears only when end users try to run Setup. System means that a password prompt appears every time when the computer is powered on or when end users try to run Setup.	<b>Setup</b> System
APIC Mode	This field is used to enable or disable the APIC (Advanced Programmable Interrupt Controller). Due to compliance with PC2001 design guide, the system is able to run in APIC mode. Enabling APIC mode will expand available IRQ resources from the system.	<b>Enabled</b> Disabled
MPS Version Control for OS	This field allows you to select which MPS (Multi-Processor Specification) version to be used for the operating system. You need to select the MPS version supported by your operating system. To find out which version to use, consult the vendor of your operating system.	<b>1.4</b> 1.1

# Advanced Chipset Features

The advanced chipset features setup option is used to change the values of the chipset registers. These registers control most of the system options in the computer.

**NOTE:** Change these settings only if you are familiar with the chipset.

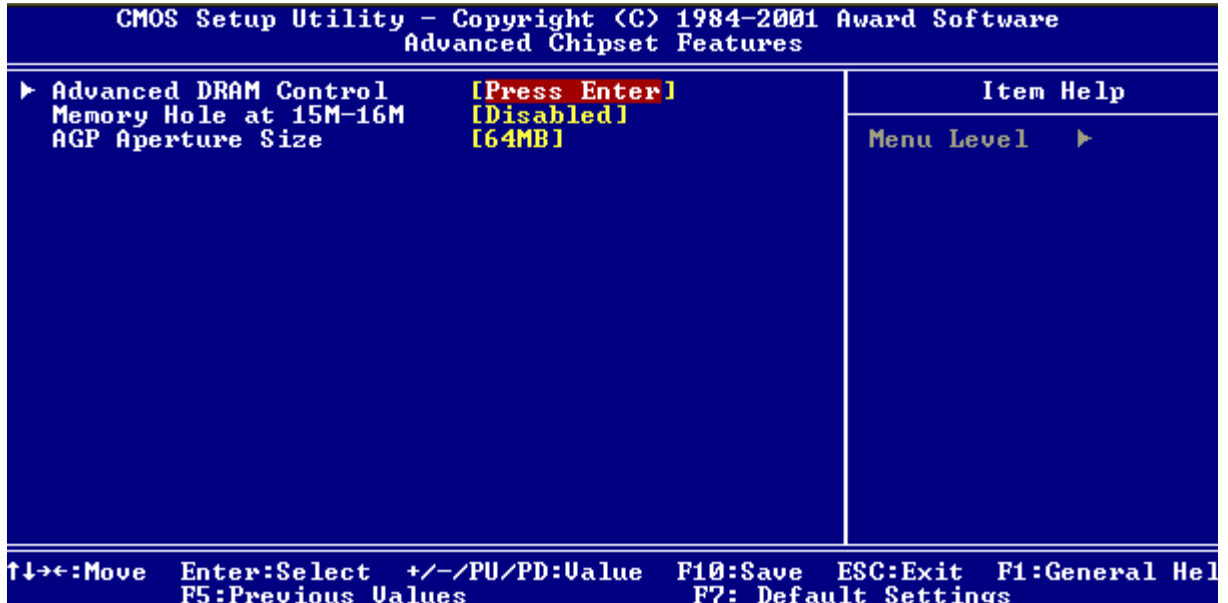

## Advanced DRAM Control

Press [Enter] to enter the sub-menu and the following screen appears:

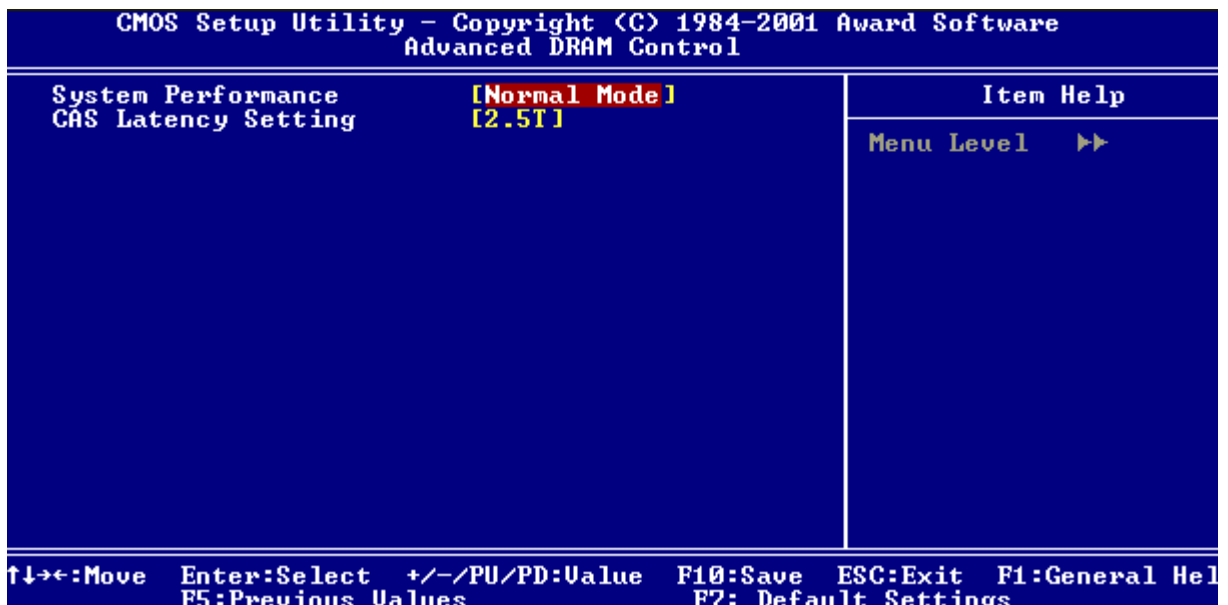



The following table describes each parameter under the sub-menu. Settings in **boldface** are the default and suggested values.

Parameter	Description	Options
System Performance	The DRAM timing is controlled by the DRAM Timing Registers. The timings programmed into this register are dependent on the system design. Slower rates may be required in certain system designs to support loose layouts or slower memory.	<b>Normal Mode</b> Safe Mode Fast mode Turbo Mode Ultra Mode
CAS Latency Setting	When synchronous DRAM is installed, the number of clock cycles of CAS latency depends on the DRAM timing.	2T, <b>2.5T</b> , 3T

The other two parameters under the Advanced Chipset Features are presented below. Settings in **boldface** are the default and suggested values.

Parameter	Description	Options
Memory Hole at 15M-16M	You can reserve this area of system memory for ISA adapter ROM. When this area is reserved, it cannot be cached. The user information of peripherals that need to use this area of system memory usually discuss their memory requirements.	<b>Disabled</b> Enabled
AGP Aperture Size (MB)	This item lets you determine the effective size of the AGP Graphic Aperture.	<b>64</b> , 4,8,16,32,128 and 256.

# Integrated Peripherals

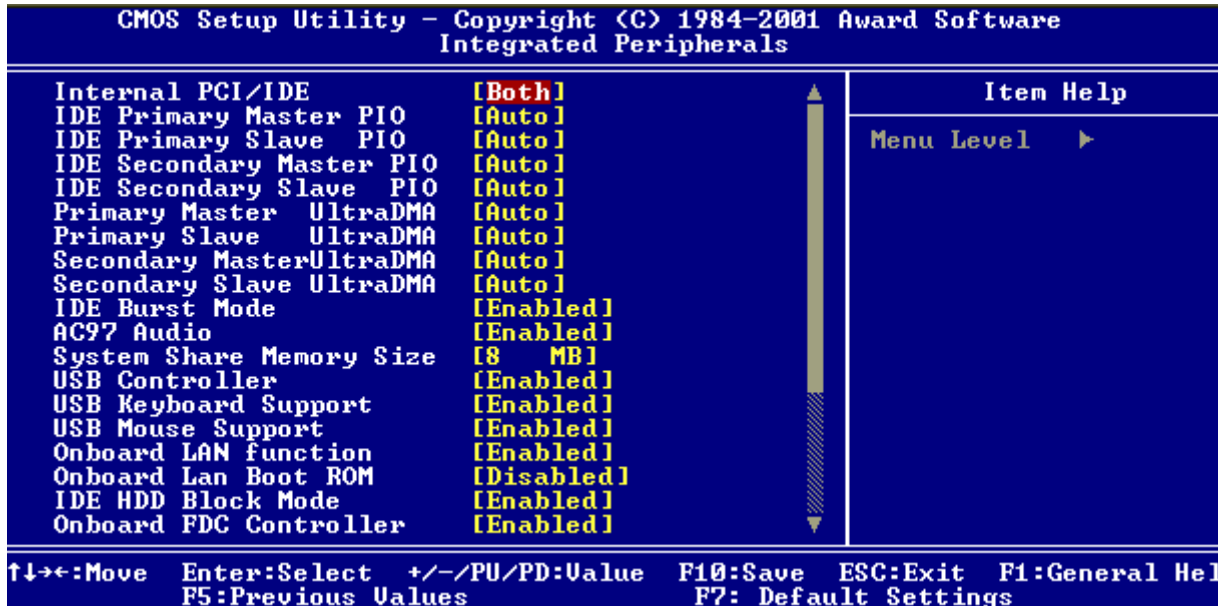

The following table describes each Integrated Peripherals parameters. Settings in boldface are the default and suggested values.

Parameter	Description	Options
Internal PCI/IDE	This setting enables or disables the internal primary and secondary PCI & IDE controllers.	<b>Both</b> , Disabled, Primary, Secondary
IDE Primary Master PIO IDE Primary Slave PIO IDE Secondary Master PIO IDE Secondary Slave PIO	Setting these items to "Auto" activates the HDD speed auto-detect function. The PIO mode specifies the data transfer rate of the HDD. For example, mode 0 data transfer rate is 3.3MB/s, mode 1 is 5.2 MB/s, mode 2 is 8.3MB/s, mode 3 is 11.1 MB/s and mode 4 is 16.6MB/s. If your hard disk performance becomes unstable, you may manually try the slower mode.	<b>Auto</b> , mode 1, mode 2, mode 3 and mode 4
Primary Master UltraDMA Primary Slave UltraDMA Secondary Master UltraDMA Secondary Slave UltraDMA	These items allow you to set the Ultra DMA 33/66/100 mode supported by the hard disk drive connected to your primary and secondary IDE connectors.	<b>Auto</b> Disabled
IDE Burst Mode	This allows your hard disk controller to use the fast block mode to transfer data to and from the hard disk drive.	<b>Enabled</b> Disabled
AC97 Audio	Enabling the on-die AC97 Auto if no add-on PCI audio device.	<b>Auto</b> Disabled
System Share Memory Size	For SiS650 chipset, the system shares memory to the onboard VGA card. This setting controls the exact memory size shared to the VGA card.	4, 8, 16, <b>32</b> , 64MB
USB Controller	This item is used to enable or disable the on-chip USB.	<b>Enabled</b> Disabled

Parameter	Description	Options
USB Keyboard Support	This item lets you enable or disable the USB keyboard driver within the onboard BIOS. The keyboard driver simulates legacy keyboard command and lets you use a USB keyboard during POST or after boot if you do not have a USB driver in the operating system.	<b>Enabled</b> Disabled
USB Mouse Support	This item lets you enable or disable the USB mouse driver within the onboard BIOS. The keyboard driver simulates legacy mouse command and lets you use a USB mouse during POST or after boot if you do not have a USB driver in the operating system.	<b>Enabled</b> Disabled
Onboard LAN function	To enable or disable the onboard LAN controller	<b>Enabled</b> Disabled
Onboard LAN Boot ROM	This setting determines whether or not to activate the boot ROM of the onboard LAN chip.	<b>Enabled</b> Disabled
IDE HDD Block Mode	Block mode is also called block transfer, multiple commands or multiple sector read/write. If your IDE hard drive supports block mode (most new drives do), select "Enabled" for automatic detection of the optimal number of block read/write per sector the drive can support.	<b>Enabled</b> Disabled
Onboard FDC Controller	Setting this parameter to "Enable" allows you to connect your floppy disk drives to the onboard floppy disk connector instead of a separate controller card. Change the setting to "Disabled" if you want to use a separate controller card.	<b>Enabled</b> Disabled

# Power Management Setup

The Power Management menu lets you configure your system to most effectively save energy while operating in a manner consistent with your own style of computer use.

The following screen shows the Power Management parameters and their default settings:

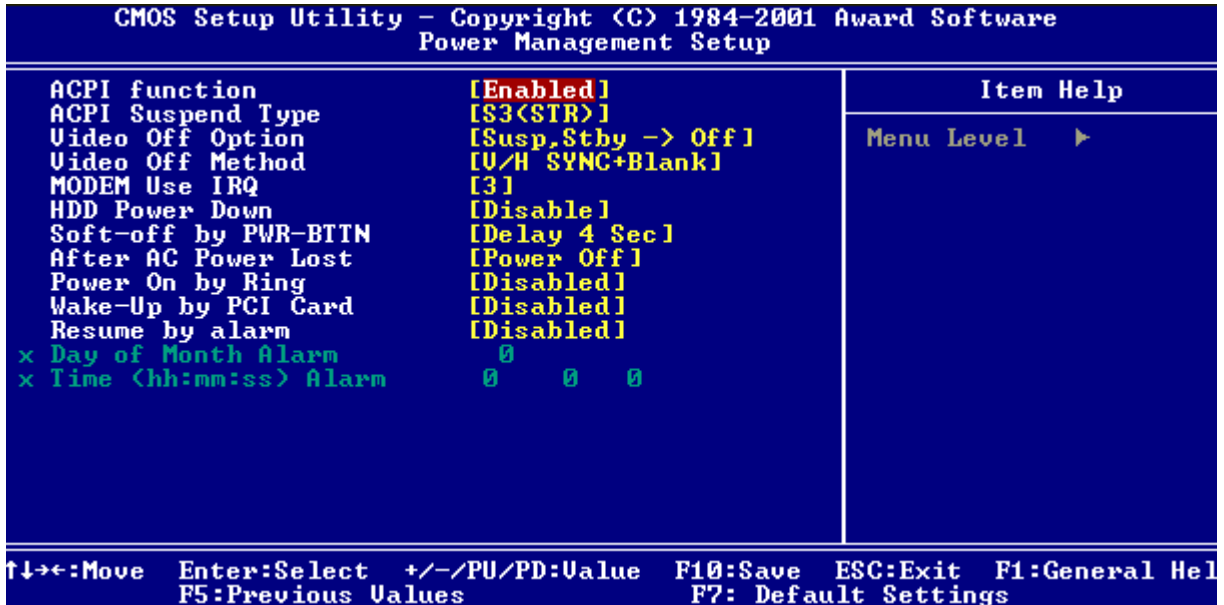

The following table describes the parameters found in this menu. Settings in **boldface** are the default and suggested settings.

Parameter	Description	Options
ACPI Function	This item is to activate the ACPI (Advanced Configuration and Power Management Interface) Function. If your operating system is ACPI-aware, such as Windows 98SE/2000/Me, select Enabled.	<b>Enabled</b> Disabled
ACPI Suspend Type	This item specifies the power saving modes for ACPI function. S1(POS): The S1 sleep mode is a low power state. In this state, no system context (CPU or chipset) is lost and hardware maintains all system context. S3 (STR): The S3 sleep mode is a power-down state in which power is supplied only to essential components such as main memory and wake-capable devices and all system context is saved to main memory. The information stored in memory will be used to restore the PC to the previous state when a <i>wake-up</i> event occurs. S1&S3: Both S1 and S3 will be adopted.	<b>S3</b> S1 S1&S3

Parameter	Description	Options
Video Off Option	This item is to control the mode in which the monitor will shut down. Always On: Always keep the monitor on. Suspend --> Off: During suspend mode, the monitor will shut down. Susp, Stby --> During suspend or standby mode, the monitor will shut down. All Modes --> Off: The monitor is turned off during doze, standby or suspend mode.	Always On Suspend Off <b>Susp, Stby --&gt; Off</b> All Modes
Video Off Method	This item determines the manner in which the monitor is blanked. V/H SYNC+Blank: This selection will cause the system to turn off the vertical and horizontal synchronization ports and write blanks to the video buffer. Blank Screen: This option only write blanks to the video buffer. DPMS Supported: Initial display power management signaling.	<b>V/H SYNC+Blank</b> Blank Screen DPMS Supported
Modem Use IRQ	This setting names the interrupt request (IRQ) line assigned to the modem (if any) on your system. Activity of selected IRQ always awakens the system.	<b>3, 4, 5, 7, 9, 10, 11, AUTO.</b>
HDD Power Down	If HDD activity is not detected for the length of time specified in this field, the hard disk drive will be powered down while all other devices remain active.	<b>Disabled</b> 1~15 Mins
Soft-off by PWR-BTTN	This feature allows users to configure the power button function.	<b>Instant Off:</b> The power button functions as a normal power-on/-off button. Delay 4 Sec: When you press the power button, the computer enters the suspend/sleep mode, but if the button is pressed for more than four seconds, the computer will be turned off.
Afrter PC Power Lost	This item specifies when your system reboot after a power failure or interrupt occurs.	<b>Power Off</b> Power On Last State
Power On by Ring	When enabled, any fax/modem activity wakes up the system from suspend mode.	<b>Disabled</b> Enabled
Wake-Up by PCI Card	Use PCI Wake-up system. PCI must meet PCI 2.2 specification.	<b>Disabled</b> Enabled
Resume by Alarm	Use this option to set the date and time for your computer to boot up. Date (of month) Alarm* - Indicate the month for system to boot up. Set it to 0 if you want to boot up everyday. Time (hh:mm:ss) Alarm* - Indicate the hour, minute and second for system to boot up.	<b>Disabled</b> Enabled *Set Resume by Alarm to Enable, then press "Enter" to show the range of Date and Time Alarm.

# PnP/PCI Configuration

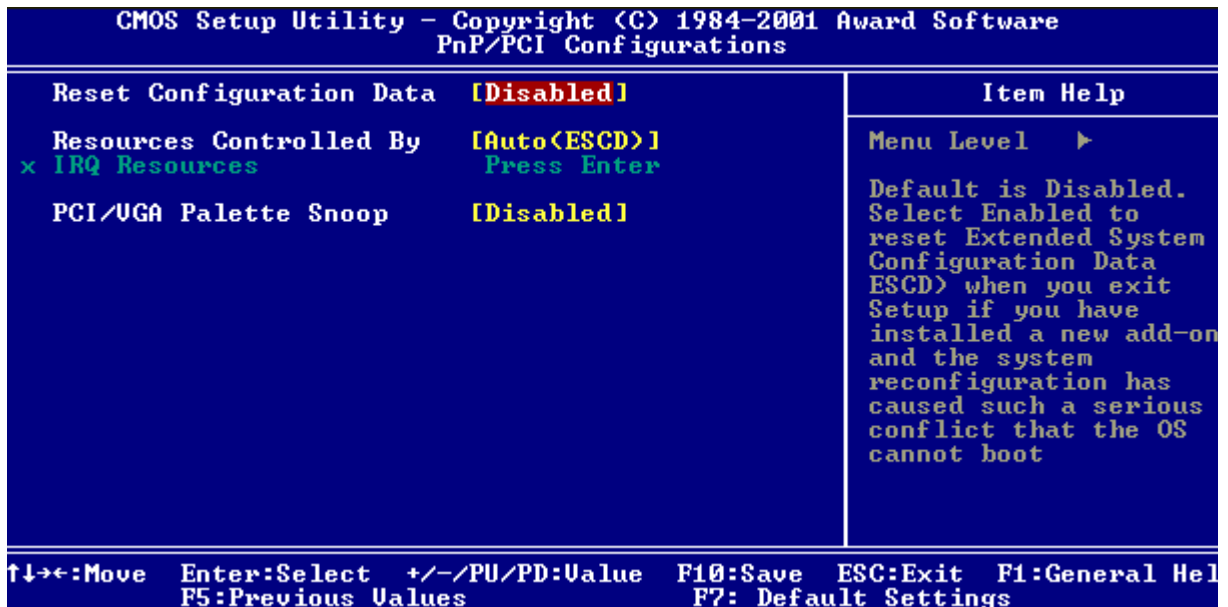

The following table describes the parameters found in this menu. Settings in **boldface** are the default and suggested settings.

Parameter	Description	Options
Reset Configuration Data	Selecting "Enabled" to reset Extended System Configuration Data (ESCD) only if you installed a new add-on and the system reconfiguration has caused such a serious conflict that the operating system can not boot. Otherwise, you should leave it unchanged.	<b>Disabled</b> Enabled
Resources Controlled By	This BIOS can automatically configure all of the boot and Plug and Play compatible devices. You can also set it as Manual and go into each of the sub menu to choose specific resources.	<b>Auto (ESCD)</b> Manual
IRQ Resources	The items are adjustable only when "Resources Controlled By" is set to Manual. By pressing "Enter" to access the sub menu.	PCI Device Reserved
PCI/VGA Palette Snoop	Disabled - Data read or written by the CPU is only directed to the PCI VGA device's palette registers. Enabled - Data read or written by the CPU is directed to both the PCI VGA device's palette registers and the ISA VGA device's palette registers, permitting the palette registers of both VGA devices to be identical.	<b>Disabled</b> Enabled *If any ISA bus adapter in the system requires VGA Palette snooping, the setting must be set to "Enabled".

**NOTE:** It is strongly recommended that only experienced users should make any changes to the default settings.

# PC Health Status

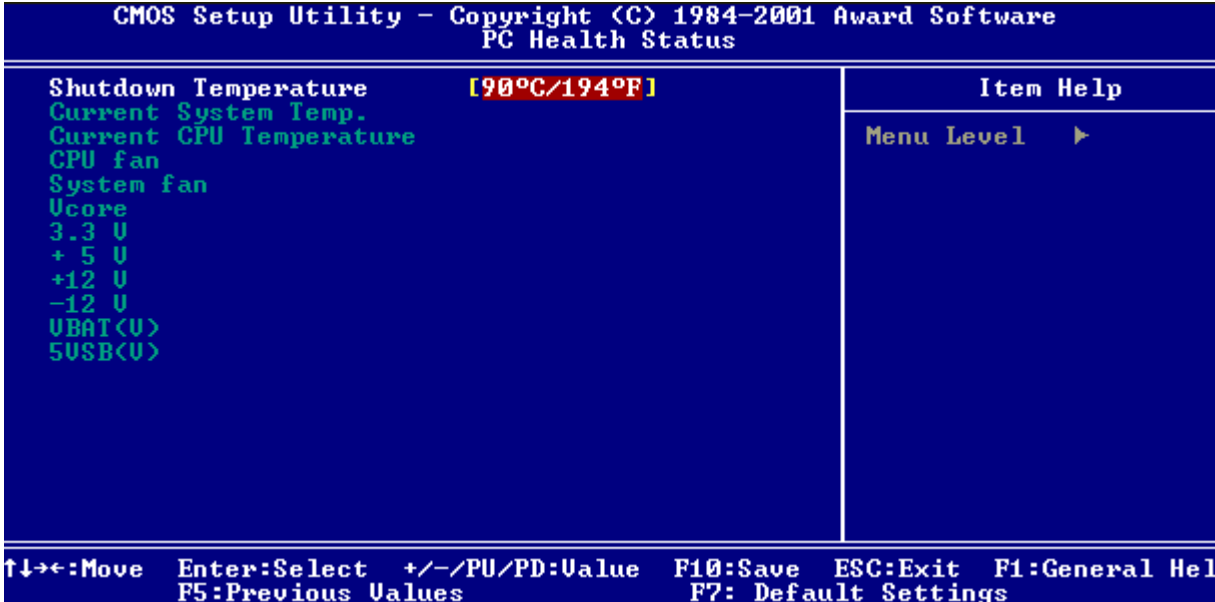

The following table describes the parameters found in this menu:

Parameter	Description	Options
Shutdown Temperature	This option is for setting the shutdown temperature level for the processor. When the processor reaches the temperature you set, the ACPI-aware system will be shut down.	
Current System/CPU Temperature, CPU/ System fan, Vcore, ect.	These items display the current status of all of the mainboard hardware devices/components such as CPU voltages, temperatures and all fans' speeds.	

# Frequency Control

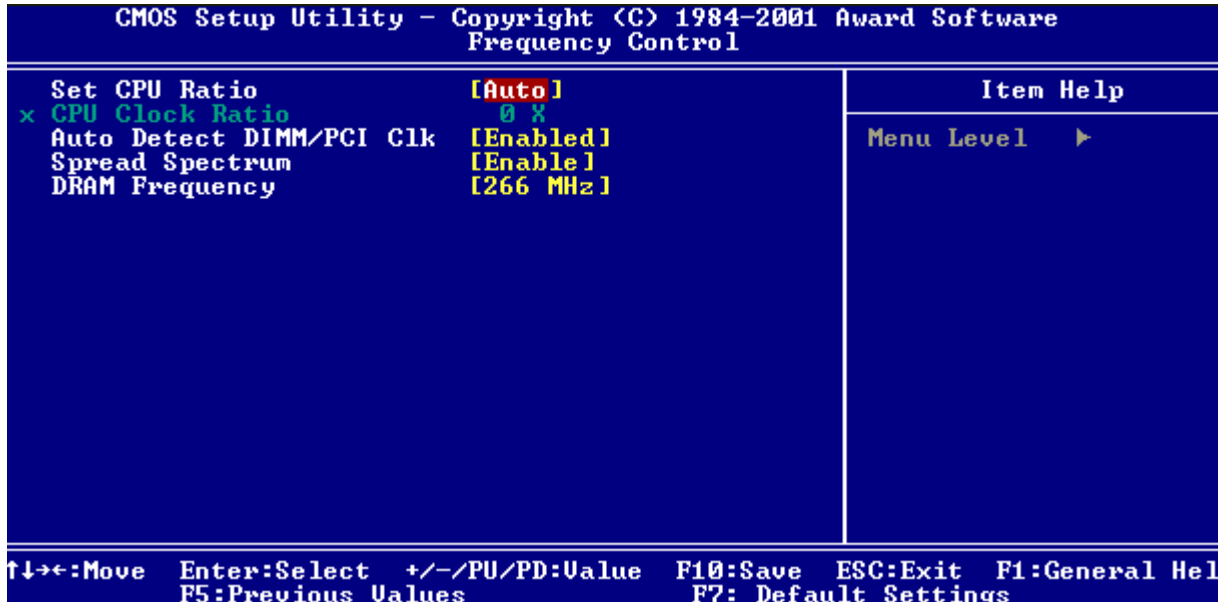

The following table describes the parameters found in this menu. Settings in **boldface** are the default and suggested settings.

Parameter	Description	Options
Set CPU Ratio	End users can overlock the processor by specifying the CPU ratio (clock multiplier) in this field.	<b>Auto</b> Manual
CPU Clock Ratio	If the CPU Ratio is set to Manual, end users can choose a suitable ratio to support the CPU.	8x to 50x
Auto Detect DIMM/PCI Clk	This option allows you to enable/disable the feature of auto detecting the clock frequency of the installed DIMM/PCI bus.	Enabled Disabled
Spread Spectrum	When the motherboard's clock generator pulses, the extreme values (spikes) of the pulses creates EMI (Electromagnetic Interference). The spread Spectrum function reduces the EMI generated by modulating the pulses so that the spikes of the pulses are reduced to flatter curves. If you do not have any EMI problem, leave the setting at Disabled for optimal system stability and performance. But if you are plagued by EMI, setting to Enabled for EMI reduction. Remember to disable Spread Spectrum if you are overlocking because even a slight jitter can introduce a temporary boost in clockspeed which may just cause your overlock ed processor to lock up.	
DRAM Frequency	This setting let end users select the DRAM frequency.	By SPD 200 Mhz 266 Mhz 333 Mhz



# Load Default Settings

The default settings are the default values set by the mainboard manufacturer specifically for optimal performance of the mainboard. When you select the item, a message as below appears:

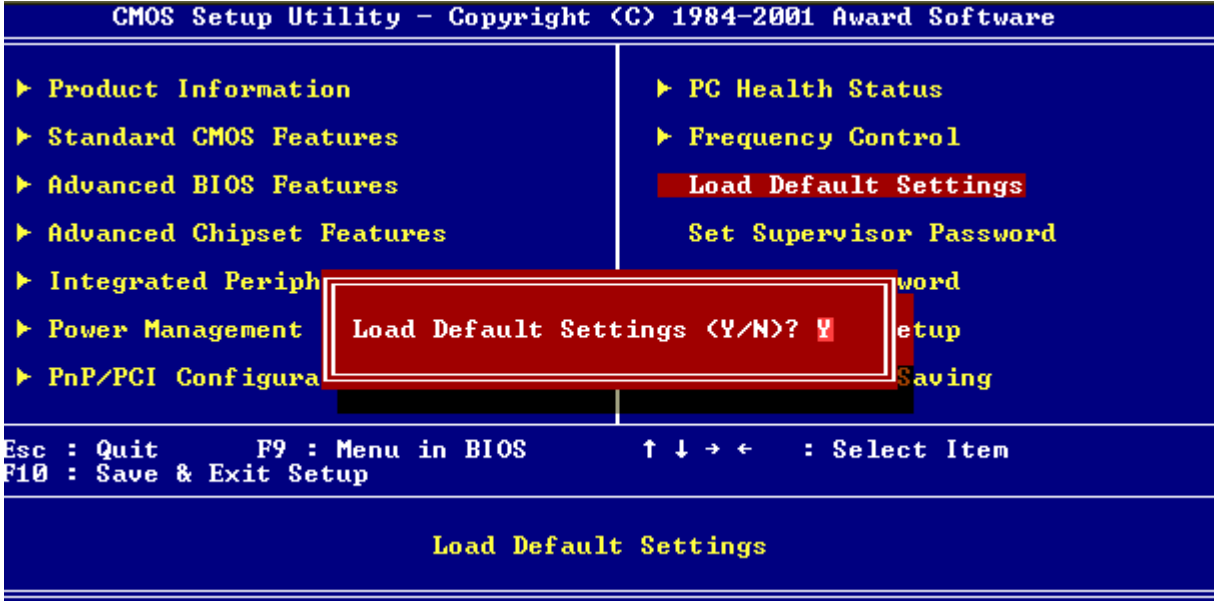

Pressing Y (Yes) loads the BIOS default values for the most stable system performance.

# Set Supervisor/User Password

When you choose to set supervisor password, a message as below will appear on the screen:

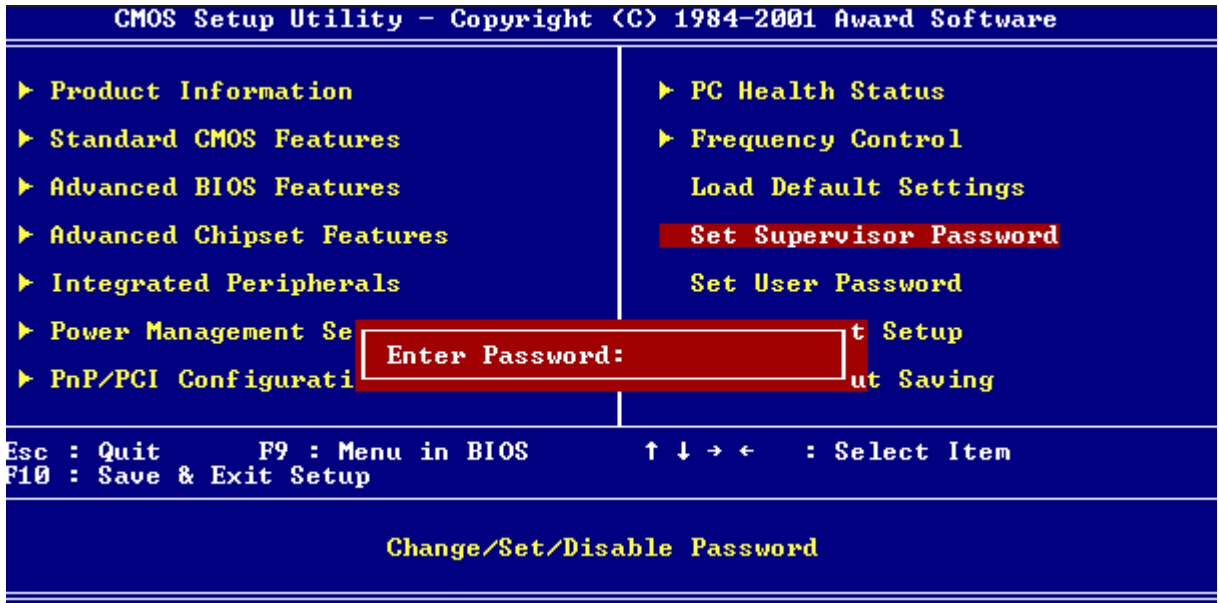

At the prompt, type your password. Your password can be up to **six** characters in length. After typing the password, press "Enter". At the next prompt, re-type your password and press "Enter" again to confirm the new password. After the password entry, the screen automatically reverts to the main screen.

To disable the password, press "Enter" when prompted to enter the password. The following screen will display a message confirming that the password has been disabled.

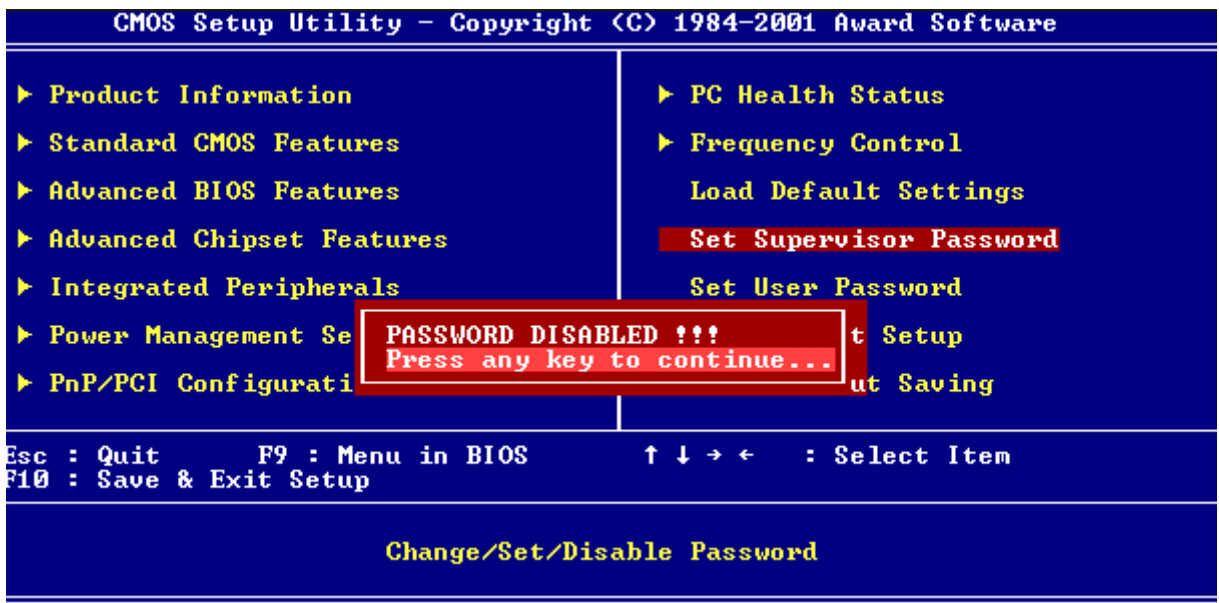

If you select Set User Password, a message as below will appear:

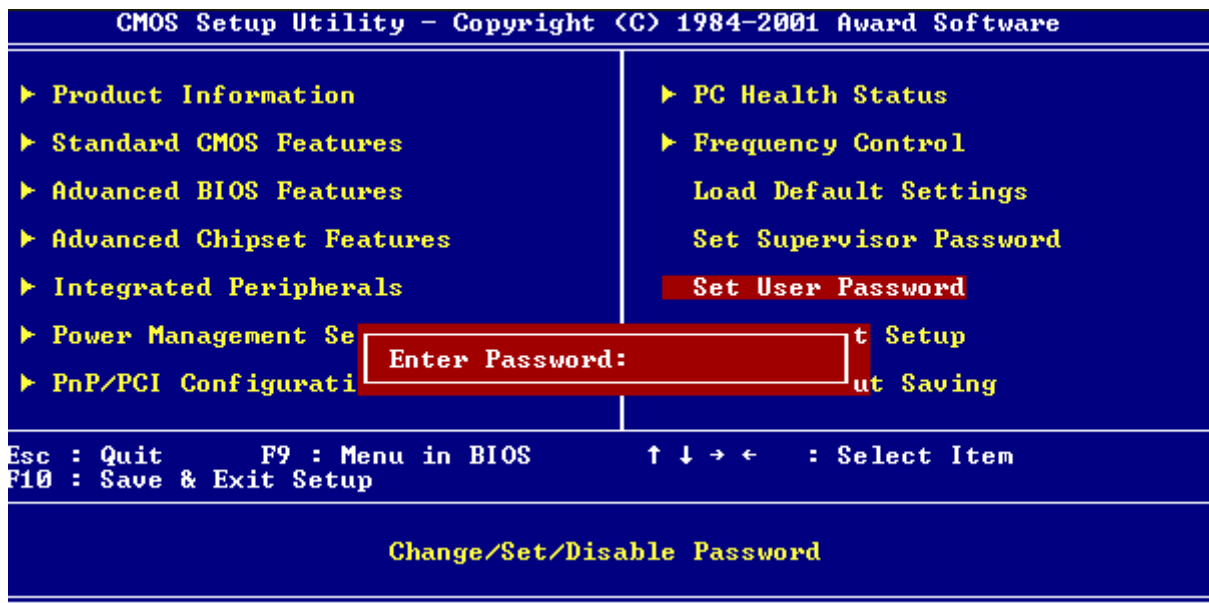

At the prompt, type your password. Your password can be up to **six** characters in length. After typing the password, press "Enter". At the next prompt, re-type your password and press "Enter" again to confirm the new password. After the password entry, the screen automatically reverts to the main screen.

To disable User Password, press "Enter" when prompted to enter the password. The following screen will display a message confirming that the password has been disabled.

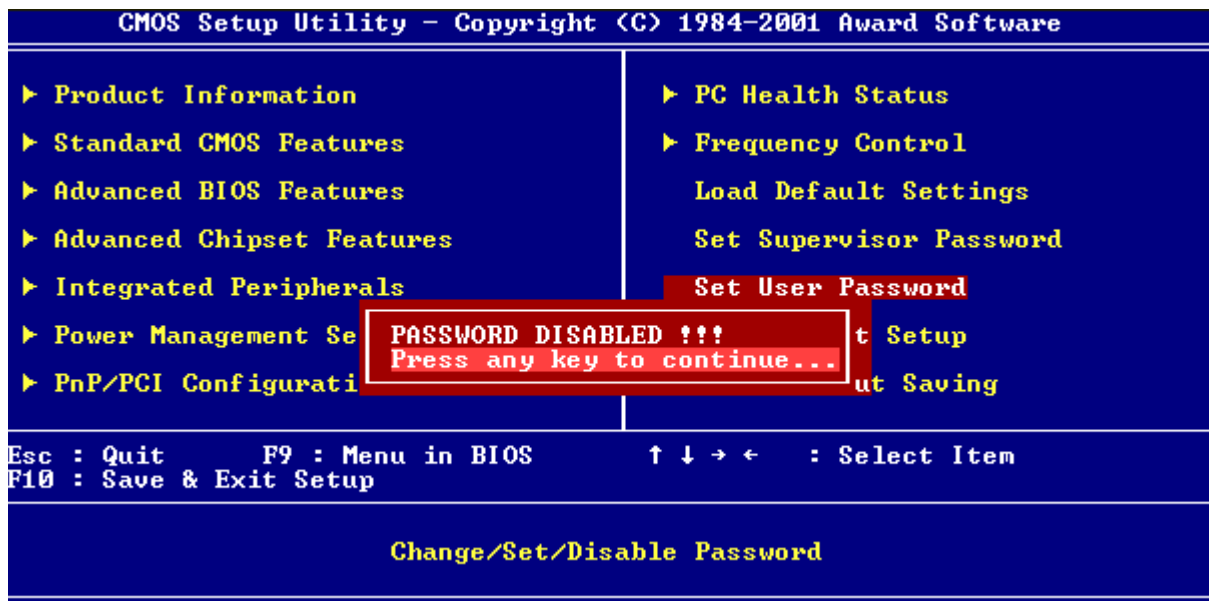

## Save & Exit Setup/Exit Without Saving

If you select Save and Exit Setup, you will exit the BIOS utility. The following dialogue box will appear.

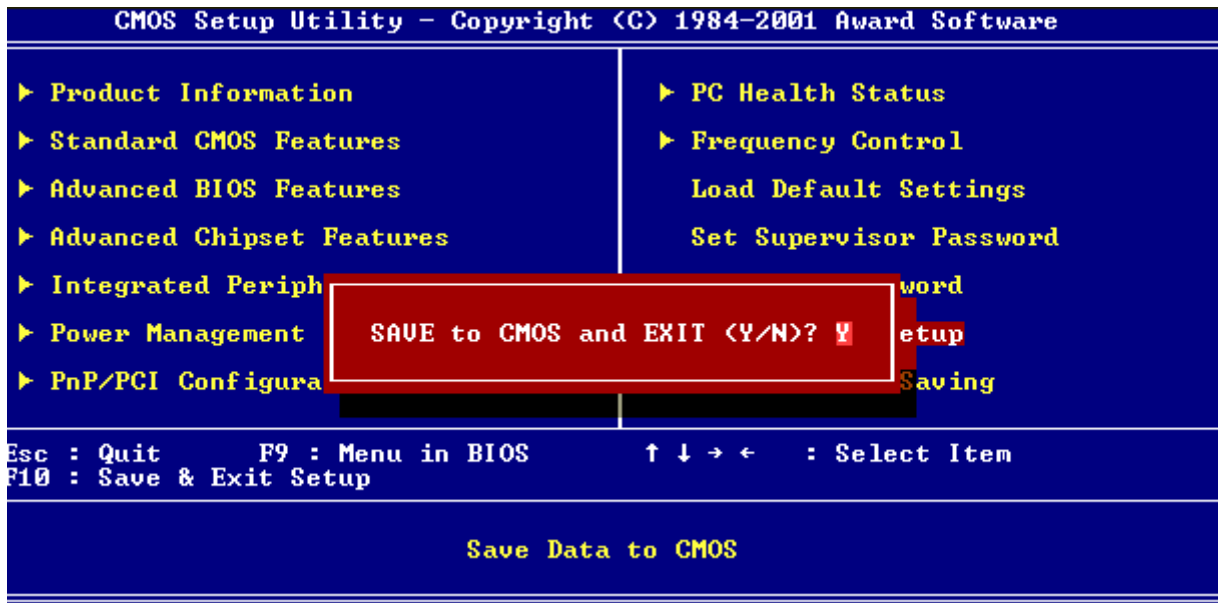

Select Y (Yes) to exit Setup. Select N (No) to return to the main menu.

If you select Exit Without Saving, you will discard all the changes you made and exit Setup.

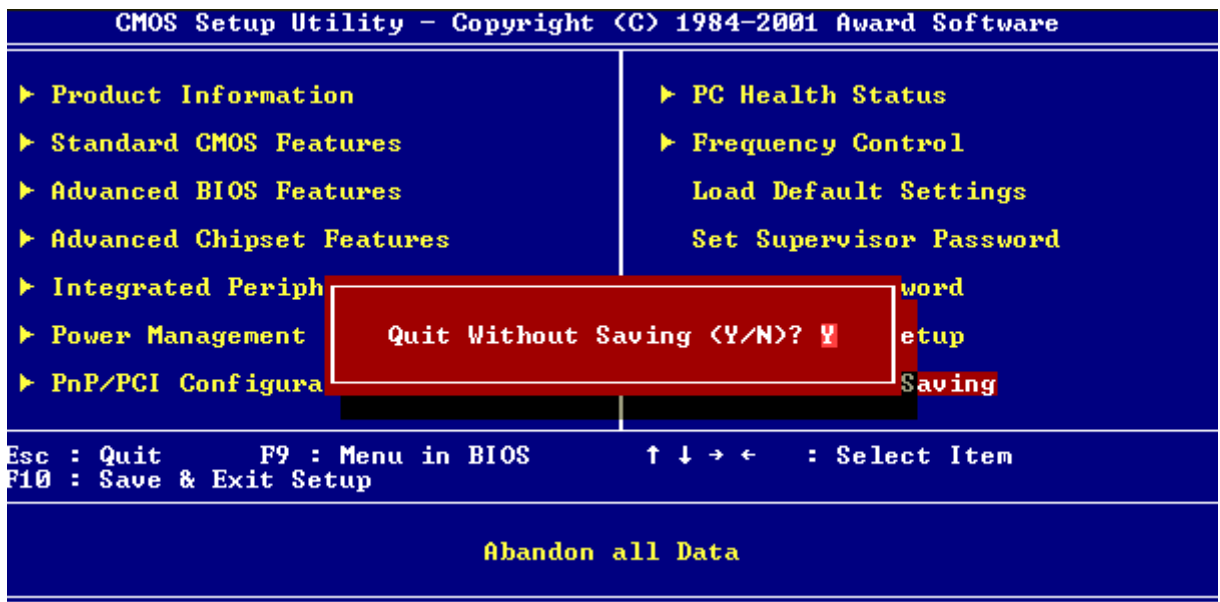



## Machine Disassembly and Replacement

---

This chapter contains step-by-step procedures on how to disassemble the Veriton 3300/3300D desktop computer for maintenance and troubleshooting.

To disassemble the computer, you need the following tools:

- Wrist grounding strap and conductive mat for preventing electrostatic discharge
- Flat-bladed screwdriver
- Phillips screwdriver
- Hexagonal screwdriver
- Plastic stick

**NOTE:** The screws for the different components vary in size. During the disassembly process, group the screws with the corresponding components to avoid mismatches when putting back the components.

---

## General Information

### Before You Begin

Before proceeding with the disassembly procedure, make sure that you do the following:

1. Turn off the power to the system and all peripherals.
2. Unplug the AC adapter and all power and signal cables from the system.

# Disassembly Procedure Flowchart

The flowchart on the succeeding page gives you a graphical representation on the entire disassembly sequence and instructs you on the components that need to be removed during servicing.

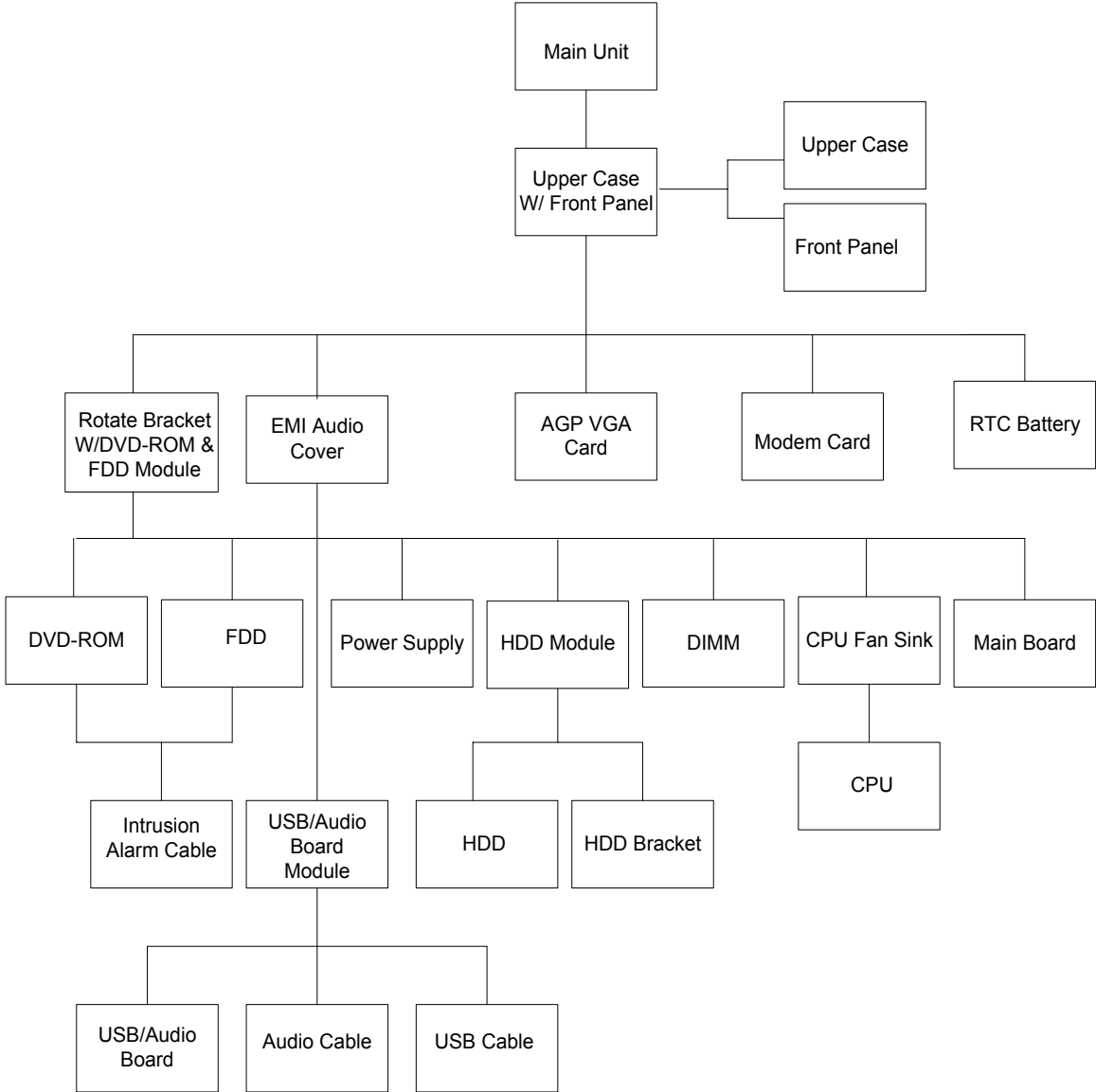



---

## Opening the Housing

This section tells you how to open the housing cover when you need to install additional components inside the system unit.

**CAUTION:** Before you proceed, make sure that you have turned off the system and all peripherals connected to it.

### Removing the Housing Cover

1. Place the system unit on a flat, steady surface.



2. Turn the housing back.



3. Slide the upper case back out about an inch and then gently pull it outward to detach it from the housing.



---

## Removing the Front Panel

1. See “Opening the Housing” on page 51
2. Remove the four screws as shown here.

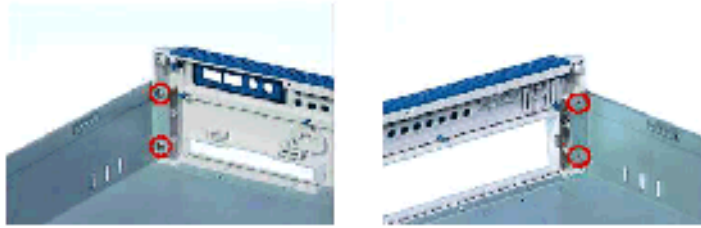

3. Detach the front bezel from the front panel gently in the way as shown here.

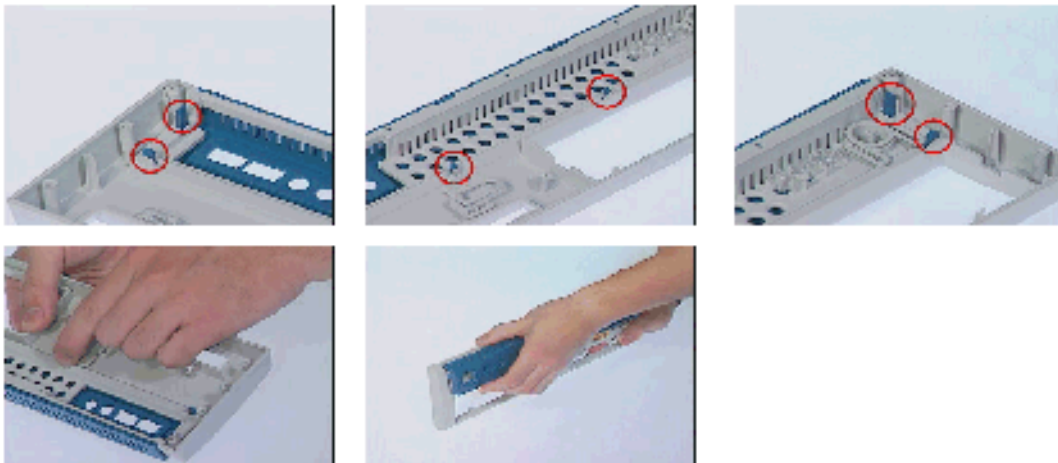

## Removing the EMI Audio Cover

1. See “Opening the Housing” on page 51
2. Remove the EMI audio cover from the lower case.



---

## Removing the Modem Card

1. See “Opening the Housing” on page 51
2. Remove the screw as shown below and then remove the modem card from the slot.

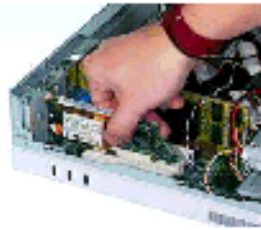

## Removing the AGP VGA Card

1. See “Opening the Housing” on page 51
2. Remove the screw as shown here and then remove the AGP VGA card from the slot.

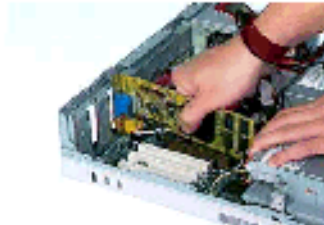

## Removing the FDD and DVD Frame

1. See “Opening the Housing” on page 51
2. Push the two latches of both sides then lift up the FDD and DVD frame.



3. Disconnect the floppy disk drive and power cables from the floppy disk drive.



4. Disconnect the power cable, IDE cable, and audio cable from the DVD-ROM drive.



5. Disconnect the micro switch cable from the main board.

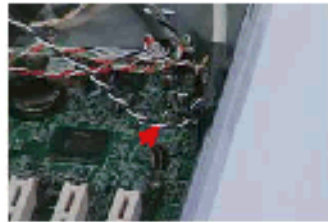

6. Pull the FDD and DVD frame from the lower case.

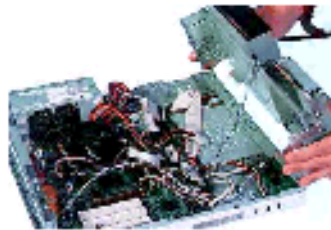

7. Remove the four screws as shown here then detach the DVD-ROM drive from the frame.

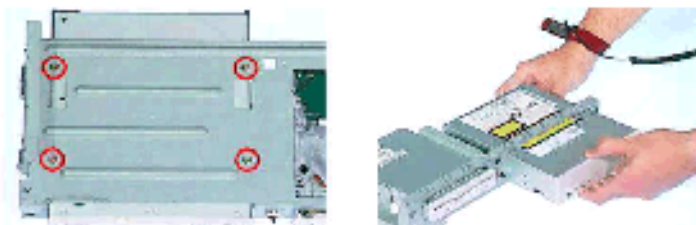

- 
8. Remove the four screws as shown here then detach the floppy disk drive from the frame.

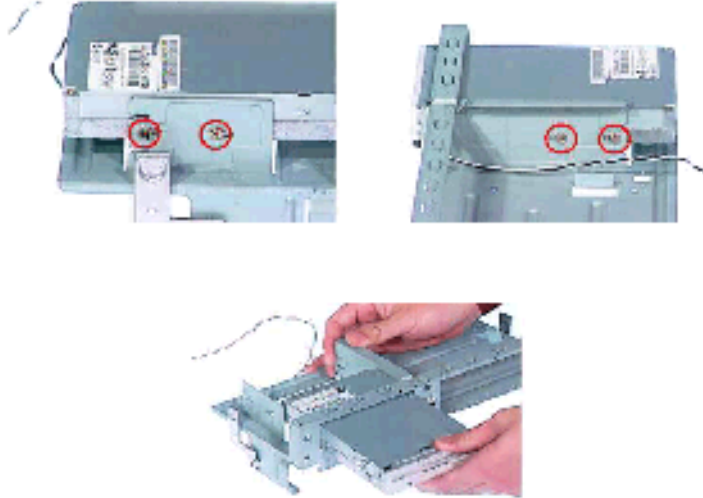

9. Disconnect micro switch cable from the FDD and DVD frame.



## Removing the Intrusion Alarm Cable

1. See "Opening the Housing" on page 51
2. See "Removing the FDD and DVD Frame" on page 53"
3. Detach the intrusion alarm cable from the FDD and DVD Frame.

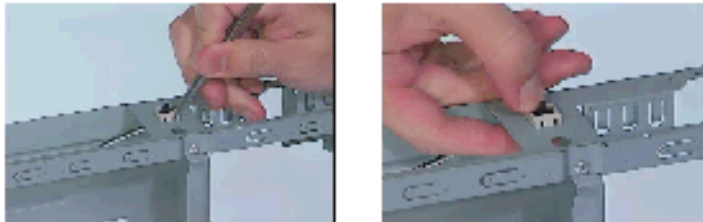

---

## Removing the USB and Audio Board

1. See “Opening the Housing” on page 51
2. See “Removing the EMI Audio Cover” on page 52
3. See “Removing the FDD and DVD Frame” on page 53
4. Disconnect the USB board cable and audio board cable from the USB and audio board.



5. Remove the two screws as shown here then detach the USB and audio board from the lower case.

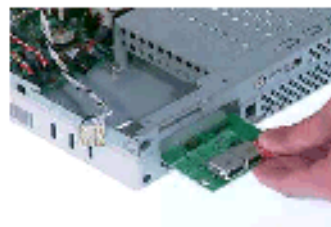

## Removing the Hard Disk Drive

1. See “Opening the Housing” on page 51
2. See “Removing the FDD and DVD Frame” on page 53
3. Disconnect the IDE cable and HDD power cable from the hard disk drive.



4. Remove the two screws as shown here and then hold the hard disk drive frame.





5. Slide the hard disk drive frame to the right and then gently move it inward to detach it from the lower case.



6. Remove the four screws as shown and then detach the hard disk drive from the frame.



## Removing the DIMM

1. See “Opening the Housing” on page 51
2. See “Removing the FDD and DVD Frame” on page 53”
3. To release the system memory, press down and out on the levers on both sides of the DIMM socket.



4. Gently pull the DIMM out of the socket.



---

## Removing the Power Supply

1. See “Opening the Housing” on page 51.
2. See “Removing the FDD and DVD Frame” on page 53”
3. Remove the two screws as shown here.



4. Disconnect the power cable from the main board.



5. Gently remove the power supply from the system.

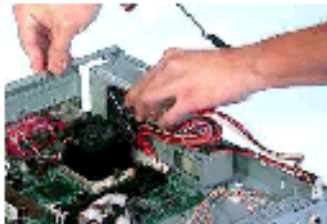

## Removing the RTC Battery

1. See “Opening the Housing” on page 51
2. To remove the RTC battery from the holder, gently remove it from the holder by hand.





---

## Removing the Processor

1. See “Opening the Housing” on page 51
2. See “Removing the FDD and DVD Frame” on page 53”
3. Disconnect the fan sink cable from the main board, and then release the two levers on both sides of the fan sink.

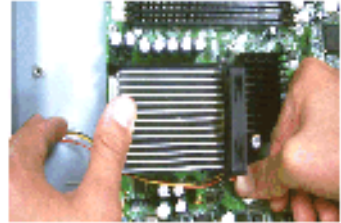
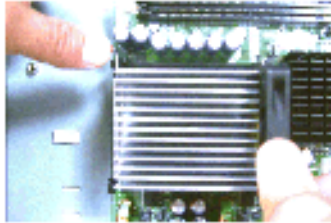
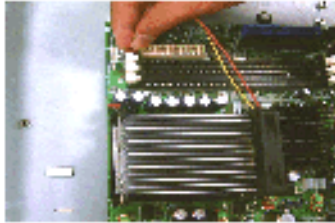

4. Put the two levers back to the original position, and then remove the CPU fan sink from the main board

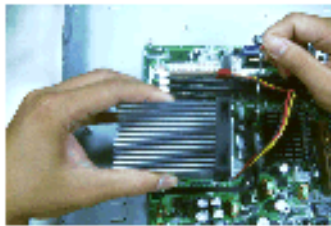

5. Lift up the socket lever, pull the CPU out from the socket carefully and then put the socket lever back to its original position.

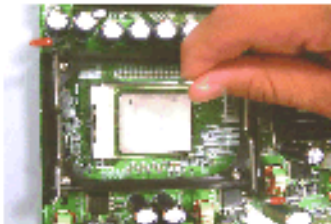

---

## Removing the Main board

1. See “Opening the Housing” on page 51
2. See “Removing the FDD and DVD Frame” on page 53
3. Remove the six screws as shown here then detach the main board from the lower case.

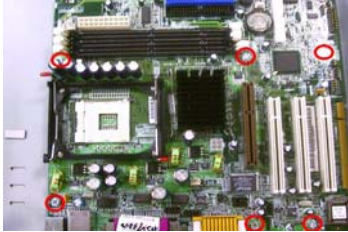



# Troubleshooting

---

This chapter provides troubleshooting information for the Aspire 3300S:

- Power-On Self-Test (POST)
- Index of Error Message
- Index of Error Symptoms
- Undetermined Problems

## Power-On Self-Test (POST)

Each time you turn on the system, the Power-on Self Test (POST) is initiated. Several items are tested during POST, but is for the most part transparent to the user.

The Power-On Self Test (POST) is a BIOS procedure that boots the system, initializes and diagnoses the system components, and controls the operation of the power-on password option. If POST discovers errors in system operations at power-on, it displays error messages on screen, generates a check point code at port 80h or even halts the system if the error is fatal.

The main components on the main board that must be diagnosed and/or initialized by POST to ensure system functionality are as follows:

- Microprocessor with built-in numeric co-processor and cache memory subsystem
- Direct Memory Access (DMA) controller (8237 module)
- Interrupt system (8259 module) or APIC (advance program interrupt controller)
- Three programmable timers (system timer and 8254 module)
- ROM subsystem
- RAM subsystem
- CMOS RAM subsystem and real time clock/calendar with battery backup
- Onboard serial interface controller
- Onboard parallel interface controller
- Embedded hard disk interface and one diskette drive interface
- Keyboard and auxiliary device controllers
- I/O ports
  - Two RS232 serial ports
  - One parallel port
  - One PS/2-compatible mouse port
  - OnePS/2-compatible keyboard port

**NOTE:** When Post executes a task, it uses a series of preset numbers called check points to be latched at port 80h, indicating the stages it is currently running. This latch can be read and shown on a debug board.

The following table describes the BIOS common tasks carried out by POST. Each task is denoted by an unique check point number. For other unique check point numbers that are not listed in the table, refer to the corresponding product service guide.

Post Checkpoints List: The list may vary accordingly depending on your BIOS.

Checkpoint	Description
CFh	Test CMOS R/W functionality
C0h	Early chipset initialization: <ul style="list-style-type: none"><li>-Disable shadow RAM</li><li>-Disable L2 cache (socket 7 or below)</li><li>-Program basic chipset registers</li></ul>
C1h	Detect memory <ul style="list-style-type: none"><li>-Auto-detection of DRAM size, type and ECC.</li><li>-Auto-detection of L2 cache (socket 7 or below)</li></ul>
C3h	Expand compressed BIOS code to DRAM
C5h	Call chipset hook to copy BIOS back to E000 & F000 shadow RAM.
0h1	Expand the Xgroup codes locating in physical address 1000:0
02h	Reserved

Checkpoint	Description
03h	Initial Superio_Early_Init switch
04h	Reserved
05h	1. Blank out screen 2. Clear CMOS error flag
06h	Reserved
07h	1. Clear 8042 interface 2. Initialize 8042 self-test
08h	1. Test special keyboard controller for Winbond 977 series Super I/O chips. 2. Enable keyboard interface.
09h	Reserved
0Ah	1. Disable PS/2 mouse interface (optional) 2. Auto detect ports for keyboard & mouse followed by a port & interface swap (optional). 3. Reset keyboard for Winbond 977 series Super I/Q chips.
0Bh	Reserved
0Ch	Reserved
0Dh	Reserved
0Eh	Test F000h segment shadow to see whether it is R/W-able or not. If test fails, keep beeping the speaker.
0Fh	Reserved
10h	Auto detect flash type to load appropriate flash R/W codes into the run time area in F000 for ESCD & DMI support.
11h	Reserved
12h	Use walking 1's algorithm to check out interface in CMOS circuitry. Also set real-time clock power status, and then check for override.
13h	Reserved
14h	Program chipset default values into chipset. Chipset default values are MODBINable by OEM customers.
15h	Reserved
16h	Initial Early_Init_Onboard_Generator switch.
17h	Reserved
18h	Detect CPU information including brand, SMI type (Cyrix or Intel) and CPU level (586 or 686)
19h	Reserved
1Ah	Reserved
1Bh	Initial interrupts vector table. If no special specified, all H/W interrupts are directed to SPURIOUS_INT_HDLR & S/W interrupts to SPURIOUS_soft_HDLR.
1Ch	Reserved
1Dh	Initial Early_PM_INIT switch.
1Eh	Reserved
1Fh	Load keyboard matrix (notebook platform)
20h	Reserved
21h	HPM initialization (notebook platform)
22h	Reserved

Checkpoint	Description
23h	<ol style="list-style-type: none"> <li>1. Check validity of RTC value: e.g. a value of 5Ah is an invalid value for RTC minute.</li> <li>2. Load CMOS settings into BIOS stack. If CMOS checksum fails, use default value instead.</li> <li>3. Prepare BIOS resource map for PCI &amp; PnP use. If ESCD is valid, take into consideration of the ESCD's legacy information.</li> <li>4. Onboard clock generator initialization. Disable respective clock resource to empty PCI &amp; DIMM slots.</li> <li>5. Early PCI initialization <ul style="list-style-type: none"> <li>-Enumerate PCI bus number</li> <li>-Assign memory &amp; I/O resource</li> <li>-Search for a valid VGA device and VGA BIOS, and put it into C000:0</li> </ul> </li> </ol>
24h	Reserved
25h	Reserved
26h	Reserved
27h	Initialize INT 09 buffer
28h	Reserved
29h	<ol style="list-style-type: none"> <li>1. Program CPU internal MTRR (P6 &amp; PII) for 0-640K memory address.</li> <li>2. Initialize the APIC for Pentium class CPU.</li> <li>3. Program early chipset according to CMOS setup. Example: onboard IDE controller.</li> <li>4. Measure CPU speed.</li> <li>5. Invoke video BIOS.</li> </ol>
2Ah	Reserved
2Bh	Reserved
2Ch	Reserved
2Dh	<ol style="list-style-type: none"> <li>1. Initialize multi-language</li> <li>2. Put information on screen display, including Award title, CPU type, CPU speed...</li> </ol>
2Eh	Reserved
2Fh	Reserved
30h	Reserved
31h	Reserved
32h	Reserved
33h	Reset keyboard except Winbond 977 series Super I/O chips.
34h	Reserved
35h	Reserved
36h	Reserved
37h	Reserved
38h	Reserved
39h	Reserved
3Ah	Reserved
3Bh	Reserved
3Ch	Test 8254.
3Dh	Reserved
3Eh	Test 8259 interrupt mask bits for channel 1
3Fh	Reserved
40h	Test 8259 interrupt mask bits for channel 2.
41h	Reserved
42h	Reserved

Checkpoint	Description
43h	Test 8259 functionality
44h	Reserved
45h	Reserved
46h	Reserved
47h	Initialize EISA slot
48h	Reserved
49h	1. Calculate total memory by testing the last double word of each 64K page. 2. Program writes allocation for AMD K5 CPU.
4Ah	Reserved
4Bh	Reserved
4Ch	Reserved
4Dh	Reserved
4Eh	1. Program MTRR of M1 CPU. 2. Initialize L2 cache for P6 class CPU & program CPU with proper cacheable range. 3. Initialize the APIC for P6 class CPU. 4. On MP platform, adjust the cacheable range to smaller one in case the cacheable ranges between each CPU are not identical.
4Fh	Reserved
50h	Initialize USB
51h	Reserved
52h	Test all memory (clear all extended memory to 0)
53h	Reserved
54h	Reserved
55h	Display number of processors (multi-processor platform)
56h	Reserved
57h	1. Display PnP logo 2. Early ISA PnP initialization -Assign CSN to every ISA PnP device.
58h	Reserved
59h	Initialize the combined Trend Anti-Virus code.
5Ah	Reserved
5Bh	(Optional Feature) Show message for entering AWDFLASH.EXE from FDD (optional)
5Ch	Reserved
5Dh	1. Initialize Init_Onboard_Super_IO switch. 2. Initialize Init_Onboard_AUDIO switch.
5Eh	Reserved
5Fh	Reserved
60h	Okay to enter Setup utility; i.e. not until this POST stage can users enter the CMOS setup utility.
61h	Reserved
62h	Reserved
63h	Reserved
64h	Reserved
65h	Initialize PS/2 Mouse
66h	Reserved



Checkpoint	Description
67h	Prepare memory size information for function call: INT 15h ax=E820h
68h	Reserved
69h	Turn on L2 cache
6Ah	Reserved
6Bh	Program chipset registers according to items described in Setup& Auto-configuration table.
6Ch	Reserved
6Dh	1. Assign resources to all ISA PnP devices. 2. Auto assign ports to onboard COM ports if the corresponding item in Setup is set to "AUTO"
6Eh	Reserved
6Fh	1. Initialize floppy controller 2. Set up floppy related fields in 40: hardware.
70h	Reserved
71h	Reserved
72h	Reserved
73h	(Optional Feature) Enter AWDFLASH.EXE if: -AWDFLASH is found in floppy drive -ALT+F2 is pressed
74h	Reserved
75h	Detect & install all IDE devices: HDD, LS120, ZIP,CDROM.....
76h	Reserved
77h	Detect serial ports & parallel ports
78h	Reserved
79h	Reserved
7Ah	Detect & install co-processor
7Bh	Reserved
7Ch	Reserved
7Dh	Reserved
7Eh	Reserved
7Fh	1. Switch back to text mode if full screen logo is supported. -If errors occur, report errors & wait for keys -If no errors occur or F1 key is pressed to continue: Clear EPA or customization logo.
80h	Reserved
81h	Reserved
82h	1. Call chipset power management hook. 2. Recover the text fond used by EPA logo (not for full screen logo) 3. If password is set, ask for password.
83h	Save all data in stack back to CMOS.
84h	Initialize ISA PnP boot devices.

Checkpoint	Description
85h	<ol style="list-style-type: none"> <li>1. USB final Initialization</li> <li>2. NET PC: Build SYSID structure</li> <li>3. Switch screen back to text mode.</li> <li>4. Set up ACPI table at top of memory.</li> <li>5. Invoke ISA adapter ROMs.</li> <li>6. Assign IRQs to PCI devices</li> <li>7. Initialize APM</li> <li>8. Clear noise of IRQs/</li> </ol>
86h	Reserved
87h	Reserved
88h	Reserved
89h	Reserved
90h	Reserved
91h	Reserved
92h	Reserved
93h	Read HDD boot sector information for Trend Anti-Virus code
94h	<ol style="list-style-type: none"> <li>1. Enable L2 cache</li> <li>2. Program boot up speed</li> <li>3. Chipset final initialization</li> <li>4. Power management final initialization</li> <li>5. Clear screen &amp; display summary table</li> <li>6. Program K6 write allocation</li> <li>7 Program P6 class write combining .</li> </ol>
95h	<ol style="list-style-type: none"> <li>1. Program daylight saving</li> <li>2. Update keyboard LED &amp; typematic rate</li> </ol>
96h	<ol style="list-style-type: none"> <li>1. Build MP table</li> <li>2. Build &amp; update ESCD</li> <li>3. Set CMOS century to 20h or 19h</li> <li>4. Load CMOS time into DOS timer tick</li> <li>5. Build MSIRQ routing table</li> </ol>
FFh	Boot attempt (INT 19h)

## POST Error Messages List

If you cannot run the diagnostics program tests but did receive a POST error message, use “POST Error Messages List” to diagnose system problems. If you did not receive any error message, look for a description of your error symptoms in “Error Symptoms List” on page 71.

**NOTE:** When you have deemed it necessary to replace an FRU, and have done so, you must run a total system check to ensure that no other activity has been affected by the change. This system check can be done through the diagnostics program.

**NOTE:** Check all power supply voltages, switch, and jumper settings before you replace the main board. Also check the power supply voltages if you have a “system no-power” condition.

If you are unable to correct the problem by using the “BIOS Messages List” table and “Error Symptoms List” table, go to “Undetermined Problems” on page 75.

**NOTE:** To diagnose a problem, first find the BIOS error messages in the left column. If directed to a check procedure, replace the FRU indicated in the check procedure. If no check procedure is indicated, the first Action/FRU listed in right column is the most likely cause.

BIOS Messages	Action/FRU
CMOS Battery Bad	Battery should be replaced
CMOS Checksum Error	Check the battery and replace if necessary.
Disk Boot Failure	Insert system disk into Drive (A:) and press <b>ENTER</b> . If you assumed the system would boot from the hard drive, make sure the controller is inserted correctly and all cables are properly attached. Also be sure the disk is formatted as a boot device. Then reboot the system.
Diskette Drives or Types Mismatch Error	Run <b>Setup</b>
Display Switch Is Set Incorrectly	Determine which setting is correct, and then either turn off the system and change the jumper, or enter <b>Setup</b> and change the <b>VIDEO</b> selection.
Display Type Has Changed Since Last Boot	Configure the system for the new display type/
Error Encountered Initializing Hard Drive	Be sure the adapter is installed correctly and all cables are correctly and firmly attached. Also be sure the correct hard drive type is selected in <b>Setup</b> .
Error Encountered Initializing Hard Disk Controller	Make sure the cord is correctly and firmly installed in the bus. Be sure the correct hard drive type is selected in <b>Setup</b> . Also check if any jumper needs to be set correctly on the hard drive.
Floppy Disk CNTRLR Error or No CNTRLR Present	Make sure the controller is installed correctly and firmly. If there are no floppy drives installed, be sure the Diskette Drive selection in <b>Setup</b> is set to <b>None</b> .
Keyboard Error or No Keyboard Present	Make sure the keyboard is attached correctly and no keys are pressed during the boot. <b>NOTE:</b> If you are purposely configuring the system without a keyboard, set the error halt condition in Setup to HALT ON ALL, BUT KEYBOARD. This will cause BIOS to ignore the missing keyboard and continue the boot.
Memory Address Error	Use this location along with the memory map for your system to find and replace the bad memory chips.
Memory Parity Error	Use this location along with the memory map for your system to find and replace the bad memory chips.
Memory Size Has Changed Since Last Boot	In EISA mode, use Configuration Utility to reconfigure the memory configuration. In ISA mode, enter <b>Setup</b> and enter the <b>new memory size</b> in the memory fields.

BIOS Messages	Action/FRU
Memory Verify Error	Use this location along with your system's memory map to locate the bad chip.
Offending Address Not Found	This message is used in conjunction with the I/O CHANNEL CHECK and RAM PARITY ERROR messages when the segment that has caused problem cannot be isolated.
Offending Segment	This message is used in conjunction with the I/O CHANNEL CHECK and RAM PARITY ERROR messages when the segment that has caused problem cannot be isolated.
Press A Key To Reboot	Press any key and the system will reboot.
Press <b>F1</b> to Disable NMI, <b>F2</b> to Reboot	When the BIOS detects a Non-maskable Interrupt condition during boot, this will allow you to disable the NMI and continue to boot, or you can reboot the system with the NMI enabled.
RAM Parity Error	Checking for segment
System Halted	Press <b>CTRL - ALT - DEL</b> to reboot. Or plug out AC and wait for 10 seconds, then plug in AC again. Press power button to boot the system again. .
Floppy Disk(s) Fail(80)	Unable to reset floppy subsystem
Floppy Disk(s) Fail (40)	Floppy Type mismatch
Hard Disk(s) Fail (80)	HDD reset failed
Hard Disk(s) Fail (40)	HDD controller diagnostics failed
Hard Disk(s) Fail (20)	HDD initialization error
Hard Disk(s) Fail (10)	Unable to recalibrate fixed disk
Hard Disk(s) Fail (08)	Sector Verify failed
Keyboard Is Locked Out	Unlock the key
Keyboard Error Or No Keyboard Present	Make sure the keyboard is attached correctly and no keys are pressed during the boot.
Manufacturing POST loop	System will repeat POST procedure infinitely while the P15 of keyboard controller is pull low. This is also used for M/B burn in test.
BIOS ROM Checksum Error	BIOS will boot from the boot block and read BIOS binary file from FDD disk, then flash BIOS ROM (FWH - Firmware Hub).
Memory Test Fail	BIOS reports the memory test fail if the onboard memory is tested error

# Error Symptoms List

**NOTE:** To diagnose a problem, first find the error symptom in the left column. If directed to a check procedure, replace the FRU indicated in the check procedure. If no check procedure is indicated, the first Action/FRU listed in right column is the most likely cause.

Error Symptom	Action/FRU
<b>Processor / Processor Fan</b>	
<b>NOTE:</b> Normally, the processor fan should be operative, and the processor clock setting should be exactly set to match its speed requirement before diagnosing any processor problems.	
Processor fan does not run but power supply fan runs.	<ol style="list-style-type: none"> <li>1. Ensure the system is not in power saving mode. See "Power Management" in chapter 2.</li> <li>2. With the system power on, measure the voltage of processor fan connector. Its reading should be +12Vdc. Its reading should be +12Vdc. If the reading shows normal, but the fan still does not work, then replace a good fan.</li> <li>3. Main board.</li> </ol>
Processor test failed.	<ol style="list-style-type: none"> <li>1. Processor.</li> <li>2. Main board.</li> </ol>
<b>Main board and Memory</b>	
<b>NOTE:</b> Ensure the memory modules are installed properly and the contact leads are clean before diagnosing any system problems.	
Memory test failed.	<ol style="list-style-type: none"> <li>1. See "Memory"</li> <li>2. Main board</li> </ol>
Incorrect memory size shown or repeated during POST.	<ol style="list-style-type: none"> <li>1. Insert the memory modules in the DIMM sockets properly, then reboot the system.</li> <li>2. Memory module.</li> <li>3. Main board.</li> </ol>
System works but fails to enter power saving mode when the Power Management Mode is set to Enabled.	<ol style="list-style-type: none"> <li>1. Enter BIOS Setup and load default settings. In Windows Systems, check settings in Power Management Property of Control Panel.</li> <li>2. Reload software from Recovery CD.</li> </ol>
Blinking cursor only; system does not work.	<ol style="list-style-type: none"> <li>1. Diskette/IDE drive connection/cables</li> <li>2. Diskette/IDE disk drives</li> <li>3. See "Undetermined Problems".</li> <li>4. Main board</li> </ol>
<b>Diskette Drive</b>	
<b>NOTE:</b> Ensure the diskette drive is auto-setting in BIOS Setup and its read/write head is clean before diagnosing any diskette drive problems.(If only one drive is installed, please make sure the drive is connected to master connector or the drive is set to master.)	
Media and drive are mismatched.	<ol style="list-style-type: none"> <li>1. Ensure the diskette drive is configured correctly in the Disk Drives of BIOS Setup.</li> <li>2. Ensure the diskette drive is correctly formatted.</li> <li>3. Diskette drive connection/cable</li> <li>4. Diskette drive</li> <li>5. Main board</li> </ol>
Diskette drive does not work.	<ol style="list-style-type: none"> <li>1. Ensure the diskette drive is not set to None in the Disk Drives of BIOS Setup.</li> <li>2. Diskette drive power</li> <li>3. Diskette drive connection/cable</li> <li>4. Diskette drive</li> <li>5. Main board</li> </ol>
Diskette drive read/write error.	<ol style="list-style-type: none"> <li>1. Diskette.</li> <li>2. Ensure the diskette drive is not set to Write protect in the Security Options of BIOS Setup.</li> <li>3. Diskette drive cable.</li> <li>4. Diskette drive.</li> <li>5. Main board.</li> </ol>

Error Symptom	Action/FRU
Diskette drive LED comes on for more than 2 minutes when reading data.	<ol style="list-style-type: none"> <li>1. Diskette</li> <li>2. Diskette drive connection/cable</li> <li>3. Diskette drive</li> <li>4. Main board</li> </ol>
Diskette drive LED fails to light, and the drive is unable to access for more than 2 minutes.	<ol style="list-style-type: none"> <li>1. Diskette</li> <li>2. Diskette drive power</li> <li>3. Diskette drive connection/cable</li> <li>4. Diskette drive</li> <li>5. Main board</li> </ol>
Diskette drive test failed.	<ol style="list-style-type: none"> <li>1. Diskette</li> <li>2. Diskette drive</li> <li>3. Diskette drive cable</li> <li>4. Main board</li> </ol>
<b>Hard Disk Drive</b>	
<b>NOTE:</b> Ensure hard disk drive is configured correctly in BIOS Setup, cable/jumper are set correctly before diagnosing any hard disk drive problems. (If only one drive is installed, please make sure the drive is connected to master connector or the drive is set to master.)	
Hard disk drive test failed.	<ol style="list-style-type: none"> <li>1. Enter BIOS Setup and Load default settings.</li> <li>2. Hard disk drive cable.</li> <li>3. Hard disk drive.</li> <li>4. Main board.</li> </ol>
Hard disk drive cannot format completely.	<ol style="list-style-type: none"> <li>1. Enter BIOS Setup and Load default settings.</li> <li>2. Hard disk drive cable.</li> <li>3. Hard disk drive.</li> <li>4. Main board.</li> </ol>
Hard disk drive has write error.	<ol style="list-style-type: none"> <li>1. Enter BIOS Setup and Load default settings.</li> <li>2. Hard disk drive.</li> </ol>
Hard disk drive LED fails to light, but system operates normally.	<ol style="list-style-type: none"> <li>1. With the system power on, measure the voltage of hard disk LED connector.</li> <li>2. Hard drive LED cable.</li> </ol>
<b>CD/DVD-ROM Drive</b>	
<b>NOTE:</b> Ensure CD/DVD-ROM drive is configured correctly in BIOS Setup, cable/jumper are set correctly and its laser beam is clean before diagnosing any CD/DVD-ROM drive problems.	
CD/DVD-ROM drive LED doesn't come on but works normally.	<ol style="list-style-type: none"> <li>1. CD/DVD-ROM drive</li> </ol>
<p>CD/DVD-ROM drive LED flashes for more than 30 seconds before LED shutting off.</p> <p>Software asks to reinstall disc.</p> <p>Software displays a reading CD/DVD error.</p>	<ol style="list-style-type: none"> <li>1. CD/DVD-ROM may have dirt or foreign material on it. Check with a known good disc.</li> <li>2. CD/DVD-ROM is not inserted properly.</li> <li>3. CD/DVD-ROM is damaged.</li> </ol>
CD/DVD-ROM drive cannot load or eject when the system is turned on and its eject button is pressed and held.	<ol style="list-style-type: none"> <li>1. Disconnect all cables from CD/DVD-ROM drive except power cable, then press eject button to try to unload the disk.</li> <li>2. CD/DVD-ROM drive power.</li> <li>3. CD/DVD-ROM drive</li> </ol>
CD/DVD-ROM drive does not read and there are no messages are displayed.	<ol style="list-style-type: none"> <li>1. CD may have dirt or foreign material on it. Check with a known good disc.</li> <li>2. Ensure the CD/DVD-ROM driver is installed properly.</li> <li>3. CD/DVD-ROM drive.</li> </ol>
CD/DVD-ROM drive can play audio CD but no sound output.	<ol style="list-style-type: none"> <li>1. Ensure the headphone jack of the CD/DVD-ROM has an output.</li> <li>2. Turn up the sound volume.</li> <li>3. Speaker power/connection/cable.</li> <li>4. CD/DVD-ROM drive.</li> </ol>
<b>Real-Time Clock</b>	
Real-time clock is inaccurate.	<ol style="list-style-type: none"> <li>1. Ensure the information in the Date and Time of BIOS Setup is set correctly.</li> <li>2. RTC battery.</li> <li>3. Main board</li> </ol>

Error Symptom	Action/FRU
<b>Audio</b>	
Audio software program invokes but no sound comes from speakers.	1. Speaker power/connection/cable.
<b>Modem</b>	
Modem ring cannot wake up system from suspend mode.	<ol style="list-style-type: none"> <li>1. For the External Modem, make sure Power on By Ring in BIOS Setup or Power Management is set to Enabled. For the PCI modem, make sure Wake up by PCI card is set to Enabled.</li> <li>2. If PCI modem card is used, reinsert the modem card to PCI slot firmly or replace the modem card.</li> <li>3. In Win 98, ensure the telephone application is configured correctly for your modem and set to receive messages and/or fax.</li> </ol>
Data/fax modem software program invokes but cannot receive/send data/fax	1. Ensure the modem card is installed properly.
Fax/voice modem software program invokes but has no sound output. (Data files are received normally; voice from modem cannot be produced, but system sound feature works normally.)	1. Ensure the modem voice-in cable from modem adapter card to main board
<b>Video and Monitor</b>	
Video memory test failed.  Video adapter failed.	<ol style="list-style-type: none"> <li>1. Remove all non-factory-installed cards.</li> <li>2. Load default settings (if screen is readable).</li> <li>3. Main board</li> </ol>
Display problem: - Incorrect colors No high intensity Missing, broken, or incorrect characters Blank monitor(dark) Blank monitor(bright) Distorted image Unreadable monitor Other monitor problems	<ol style="list-style-type: none"> <li>1. Monitor signal connection/cable.</li> <li>2. Monitor</li> <li>3. Video adapter card</li> <li>4. Main board</li> </ol>
Display changing colors.	<ol style="list-style-type: none"> <li>1. Monitor signal connection/cable</li> <li>2. Monitor</li> <li>3. Main board</li> </ol>
Display problem not listed above (including blank or illegible monitor).	<ol style="list-style-type: none"> <li>1. "Monitor".</li> <li>2. Load default settings (if screen is readable).</li> <li>3. Main board</li> </ol>

Error Symptom	Action/FRU
<b>Parallel/Serial Ports</b>	
Execute "Load BIOS Default Settings" in BIOS Setup to confirm ports presence before diagnosing any parallel/serial ports problems.	
Serial or parallel port loop-back test failed.	<ol style="list-style-type: none"> <li>1. Make sure that the LPT# or COM# you test is the same as the setting in BIOS Setup.</li> <li>2. Loop-back.</li> <li>3. Main board.</li> </ol>
Printing failed.	<ol style="list-style-type: none"> <li>1. Ensure the printer driver is properly installed. Refer to the printer service manual.</li> <li>2. Printer.</li> <li>3. Printer cable.</li> <li>4. Main board.</li> </ol>
Printer problems.	<ol style="list-style-type: none"> <li>1. Refer to the service manual for the printer.</li> </ol>
<b>Keyboard</b>	
Some or all keys on keyboard do not work.	<ol style="list-style-type: none"> <li>1. Keyboard</li> </ol>
<b>Power Supply</b>	
Pressing power switch does not turn off system. (Only unplugging the power cord from electrical outlet can turn off the system.)	<ol style="list-style-type: none"> <li>1. Ensure the <code>Power Switch &lt; 4 sec.</code> in BIOS Setup of <code>Power Management</code> is not set to <code>Instant-off</code>.</li> <li>2. Power switch cable assembly</li> </ol>
Pressing power switch does not turn on the system.	<ol style="list-style-type: none"> <li>1. Ensure the power override switch (situated at the back of the machine, just above the connector for the power cable) is not set to <code>OFF</code>.</li> <li>2. Power switch cable assembly.</li> </ol>
Executing software shutdown from Windows98 Start menu does not turn off the system. (Only pressing power switch can turn off the system).	<ol style="list-style-type: none"> <li>1. Load default settings.</li> <li>2. Reload software from Recovery CD.</li> </ol>
No system power, or power supply fan is not running.	<ol style="list-style-type: none"> <li>1. Power Supply</li> <li>2. Main board</li> </ol>
<b>Other Problems</b>	
Any other problems.	<ol style="list-style-type: none"> <li>1. Undetermined Problems</li> </ol>



---

## Undetermined Problems

If an error message is present, go to “POST Error Messages List” on page 69. If you did not receive any messages, see if the symptom is listed in “Error Symptoms List” on page 71. If you still cannot solve the problem, continue with this check:

1. Check the power supply voltages. If the voltages are correct continue with the following steps:
2. Power off the system unit.
3. Perform the following checks, one by one, until you have isolated the problem FRU.
4. Load default settings in setup.
5. Check all main board jumper positions and switch settings.
6. Check all adapter card jumper positions.
7. Check all device jumper positions.
8. Check all cables and connectors for proper installation.
9. If the jumpers, switches and voltage settings are correct, remove or disconnect the following, one at a time:
  10. Non-Acer devices
    - External devices
    - Any adapter card (modem card, LAN card or video card, if installed)
    - CD/DVD-ROM drive
    - Diskette drive
    - Hard disk drive
    - DIMM
    - Processor
    - Main board
11. Power on the system unit.
12. Repeat steps 2 through 5 until you find the failing device or adapter.

# Jumper and Connector Information

---

## Connectors

---

The mainboard provides connectors to connect to FDD, IDE HDD, case, modem, LAN, USB Ports, IR module and CPU/System FAN.

### Floppy Disk Drive Connector: FDD1

The mainboard provides a standard floppy disk drive connector that supports 360K, 720K, 1.2M, 1.44M and 2.88M floppy disk types.

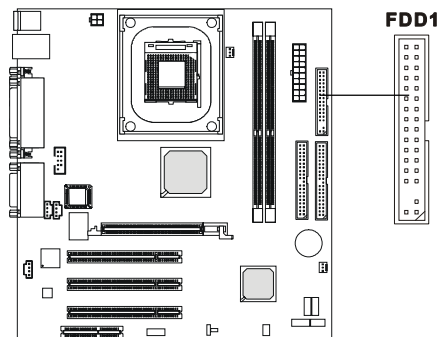

### Chassis Intrusion Switch Connector: J8

This connector is connected to 2-pin connector chassis switch. If the Chassis is open, the switch will be short. The system will record this status. To clear the warning, you must enter the BIOS setting and clear the status.

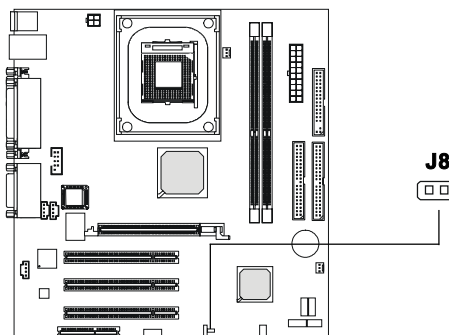

---

## Hard Disk Connectors: IDE1 & IDE2

The mainboard has a 32-bit Enhanced PCI IDE and Ultra DMA 33/66/100 controller that provides PIO mode 0~4, Bus Master, and Ultra DMA33/66/100 function. You can connect up to four hard disk drives, CD-ROM, 120MB Floppy (reserved for future BIOS) and other devices. These connectors support the provided IDE hard disk cable.

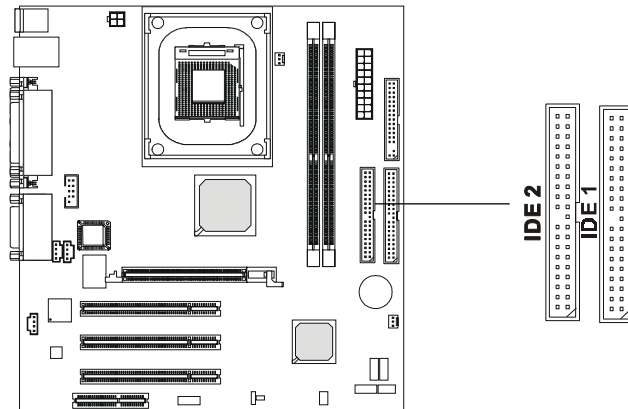

### **IDE1**(Primary IDE Connector)

The first hard drive should always be connected to IDE1. IDE1 can connect a Master and a Slave drive. You must configure second hard drive to Slave mode by setting the jumper accordingly.

### **IDE2**(Secondary IDE Connector)

IDE2 can also connect a Master and a Slave drive.



#### **TIP:**

*If you install two hard disks on cable, you must configure the second drive to Slave mode by setting its jumper. Refer to the hard disk documentation supplied by hard disk vendors for jumper setting instructions.*

---

### **CD-In Connector: JCD1**

The connector is for CD-ROM audio connector.

### **Aux Line-In Connector: JAUX1**

The connector is for DVD add-on card with Line-in connector.

### **Modem-In Connector: JMD1**

The connector is for modem with internal audio connector.

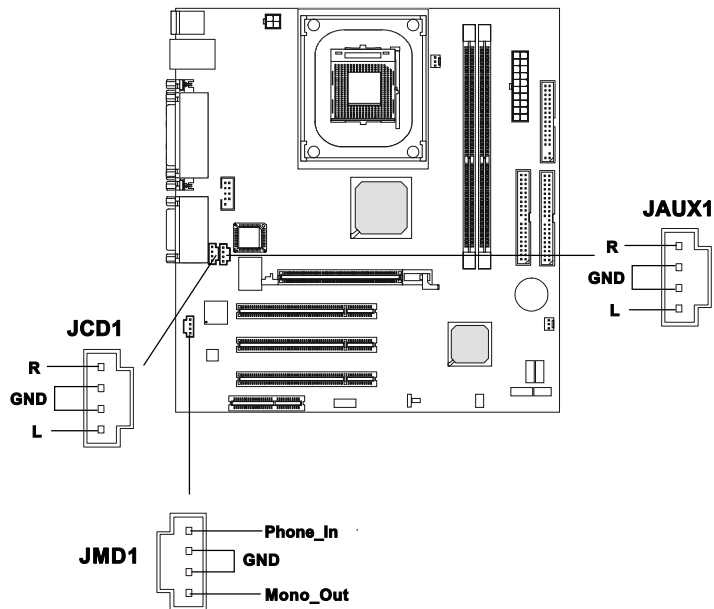

---

## Fan Power Connectors: CPUFA/SYSFA

The CPUFA (processor fan) & SYSFA (system fan) support system cooling fan with +12V. It supports three-pin head connector. When connecting the wire to the connectors, always take note that the red wire is the positive and should be connected to the +12V, the black wire is Ground and should be connected to GND. If the mainboard has a System Hardware Monitor chipset on-board, you must use a specially designed fan with speed sensor to take advantage of the CPU fan control.

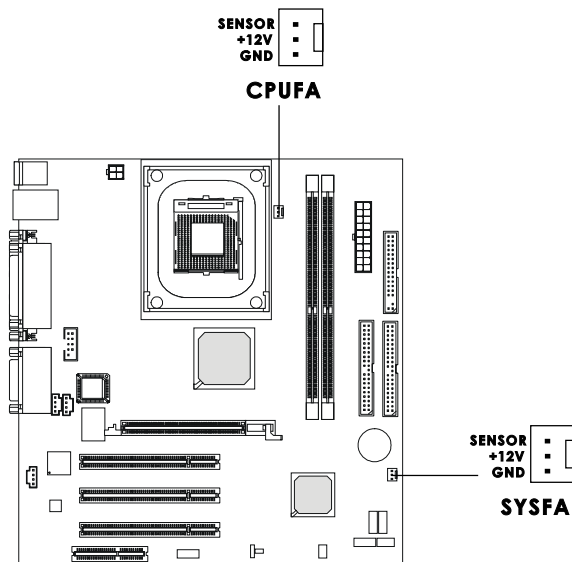

### **Note:**

1. Always consult the vendor for proper CPU cooling fan.
2. CPU Fan supports the fan control. You can install the PC Alert utility that will automatically control the CPU Fan speed according to the actual CPU temperature.

## Front Panel Connectors: JFP1 & JFP2

The mainboard provides front panel connectors for electrical connection to the front panel switches and LEDs. Users can choose either the JFP1 or the JFP2 depending on their needs. **JFP1 is compliant with Intel® Front Panel I/O Connectivity Design Guide**

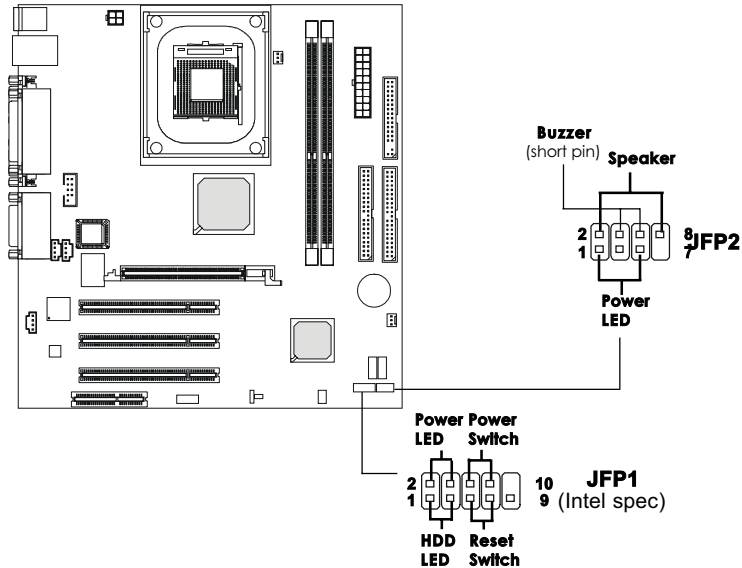

**JFP1 Pin Definition**

PIN	SIGNAL	DESCRIPTION
1	HD_LED_P	Hard disk LED pull-up
2	FP PWR/SLP	MSG LED pull-up
3	HD_LED_N	Hard disk active LED
4	FP PWR/SLP	MSG LED pull-up
5	RST_SW_N	Reset Switch low reference pull-down to GND
6	PWR_SW_P	Power Switch high reference pull-up
7	RST_SW_P	Reset Switch high reference pull-up
8	PWR_SW_N	Power Switch low reference pull-down to GND
9	RSVD_DNU	Reserved. Do not use.



### **Note for JFP2:**

If onboard buzzer is available, you can short pins 4 & 6 to have the buzzer enabled or open pins 4 & 6 to have the buzzer disabled.



**JFP2**

## Front Panel Audio Connector: JAUD

You can connect an optional audio connector to the Front Panel Audio Header. **JAUD is compliant with Intel® Front Panel I/O Connectivity Design Guide.**

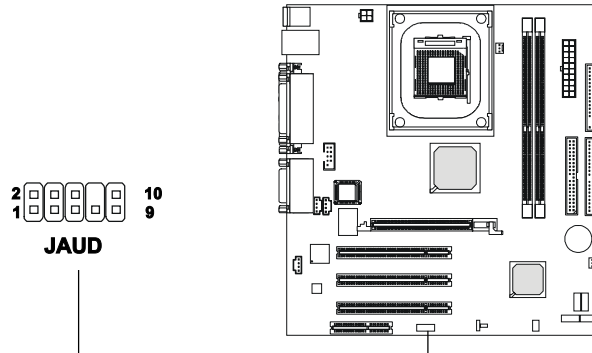

### Pin Definition

PIN	SIGNAL	DESCRIPTION
1	AUD_MIC	Front panel microphone input signal
2	AUD_GND	Ground used by analog audio circuits
3	AUD_MIC_BIAS	Microphone power
4	AUD_VCC	Filtered +5V used by analog audio circuits
5	AUD_FPOUT_R	Right channel audio signal to front panel
6	AUD_RET_R	Right channel audio signal return from front panel
7	HP_ON	Reserved for future use to control headphone amplifier
8	KEY	No pin
9	AUD_FPOUT_L	Left channel audio signal to front panel
10	AUD_RET_L	Left channel audio signal return from front panel



### **CAUTION!!!**

*If you don't want to connect to the front audio header, pins 5 & 6, 9 & 10 have to be jumpered in order to have signal output directed to the rear audio ports. Otherwise, the Line-Out connector on the back panel will not function.*

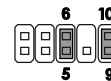

## Front USB Connector: JUSB1 or JUSB2

The mainboard provides one front Universal Serial Bus connector for users to connect to USB devices. Users can choose either the JUSB1 or the JUSB2 depending on their needs. **The JUSB1 is compliant with Intel® Front Panel I/O Connectivity Design Guide.**

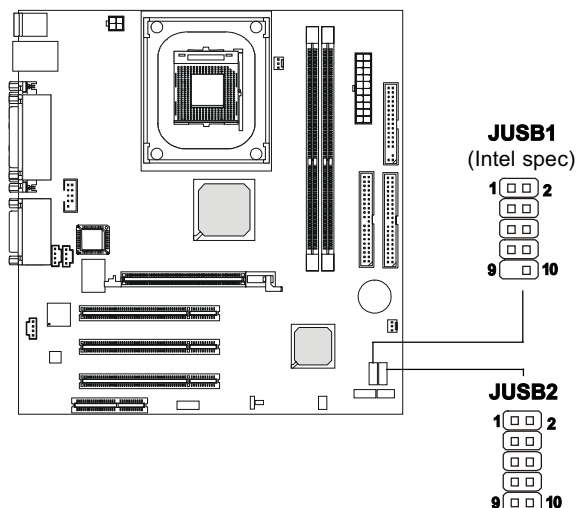

**JUSB1 Pin Definition**

Pin	Description	Pin	Description
1	VCC	2	VCC
3	USB0-	4	USB1-
5	USB0+	6	USB1+
7	GND	8	GND
9	NC	10	OC0

**JUSB2 Pin Definition**

Pin	Description	Pin	Description
1	VCC	2	GND
3	USB0-	4	GND
5	USB0+	6	USB1+
7	GND	8	USB1-
9	GND	10	VCC



---

## IrDA Infrared Module Header: JIR1

This connector allows you to connect to IrDA Infrared modules and is **compliant with Intel® Front Panel I/O Connectivity Design Guide**. You must configure the setting through the BIOS setup to use the IR function.

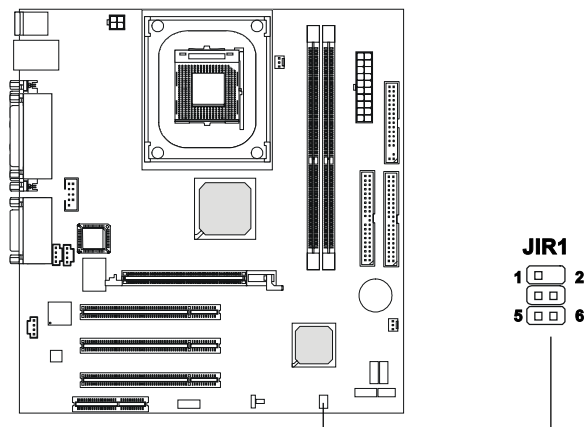

### JIR1 Pin Definition

Pin	Signal
1	NC
2	NC
3	VCC
4	GND
5	IRTX
6	IRRX

---

## Jumpers

The motherboard provides one jumper for you to set the computer's function. This section will explain how to change your motherboard's function through the use of the jumper.

### Clear CMOS Jumper: JBAT1

There is a CMOS RAM on board that has a power supply from external battery to keep the data of system configuration. With the CMOS RAM, the system can automatically boot OS every time it is turned on. That battery has long life time for at least 5 years. If you want to clear the system configuration, use the JBAT1 (Clear CMOS Jumper ) to clear data. Follow the instructions below to clear the data:

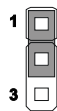
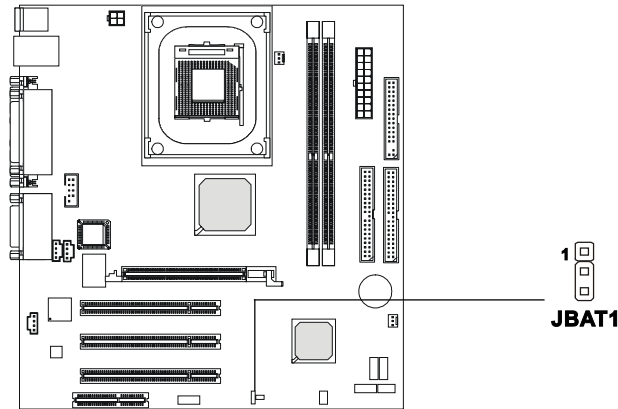

**Keep Data**

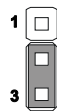

**Clear Data**



*You can clear CMOS by shorting 2-3 pin while the system is off. Then return to 1-2 pin position. Avoid clearing the CMOS while the system is on; it will damage the mainboard.*

---

## Slots

---

The motherboard provides three 32-bit Master PCI bus slots, one AGP slot and one CNR slot.

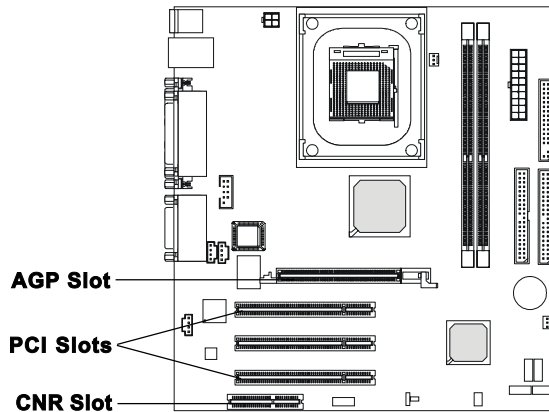

### **AGP (Accelerated Graphics Port) Slot**

The AGP slot allows you to insert the AGP graphics card. AGP is an interface specification designed for the throughput demands of 3D graphics. It introduces a 66MHz, 32-bit channel for the graphics controller to directly access main memory. The slot only supports **4x** AGP card.

### **PCI Slots**

Three PCI slots allow you to insert the expansion cards to meet your needs. When adding or removing expansion cards, make sure that you unplug the power supply first. Meanwhile, read the documentation for the expansion card to make any necessary hardware or software settings for the expansion card, such as jumpers, switches or BIOS configuration.

### **CNR (Communication Network Riser)**

The CNR slot allows you to insert the CNR expansion cards. CNR is a specially designed network, audio, or modem riser card for ATX family motherboards. Its main processing is done through software and controlled by the motherboard's chipset.

---

## PCI Interrupt Request Routing

The IRQ, abbreviation of interrupt request line and pronounced I-R-Q, are hardware lines over which devices can send interrupt signals to the microprocessor. The PCI IRQ pins are typically connected to the PCI bus INT A# ~ INT D# pins as follows:

	Order 1	Order 2	Order 3	Order 4
PCI Slot 1	INT B#	INT C#	INT D#	INT A#
PCI Slot 2	INT C#	INT D#	INT A#	INT B#
PCI Slot 3	INT D#	INT A#	INT B#	INT C#



## FRU (Field Replaceable Unit) List

---

This chapter gives you the FRU (Field Replaceable Unit) listing in global configurations of Aspire 3300S. Refer to this chapter whenever ordering for parts to repair or for RMA (Return Merchandise Authorization).

**IMPORTANT:** Please note WHEN ORDERING FRU PARTS, that you should check the most up-to-date information available on your regional web or channel. For whatever reasons a part number change is made, it will not be noted in the printed Service Guide. For ACER-AUTHORIZED SERVICE PROVIDERS, your Acer office may have a DIFFERENT part number code to those given in the FRU list of this printed Service Guide. You MUST use the local FRU list provided by your regional Acer office to order FRU parts for repair and service of customer machines.

**NOTE:** To scrap or to return the defective parts, you should follow the local government ordinance or regulations on how best to dispose it, or follow the rules set by your regional Acer office on how to return it.

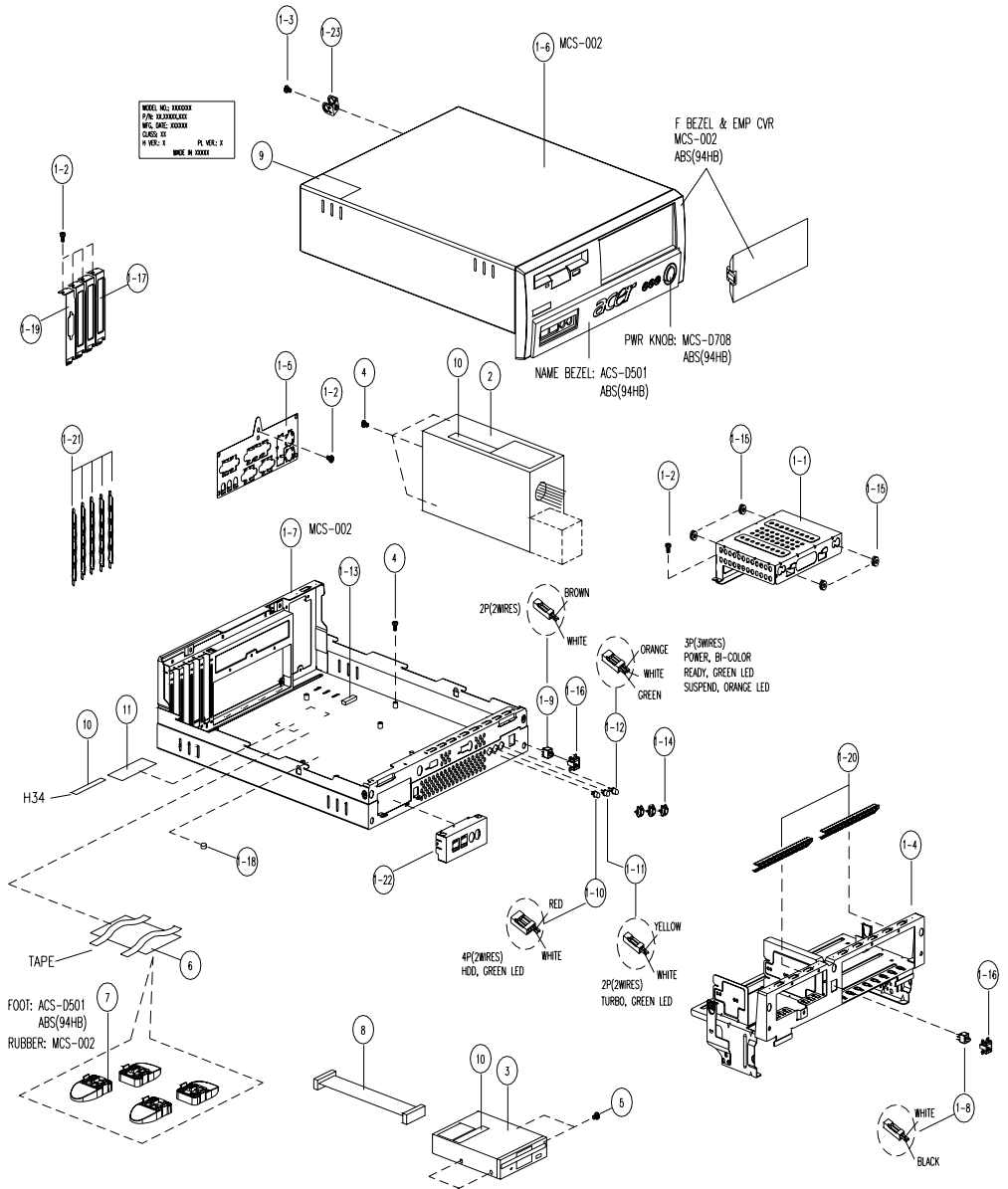

**NOTE:** The number indicates the location shown on exploded diagram or “NS” indicates “Not shown” on it.

# Aspire 3300S Exploded Diagram



Picture	No.	Partname	Description	Part No.
<b>FDD/Floppy Disk Drive</b>				
	3	FDD	MITSUMI 3 MODE FDD 1.44MB 1"H/D353M3D-R694005	KF.35301.001
	NS	U6 20G 5400RPM Seagate		56.02002.001
		U6 40G 5400RPM Seagate		56.02002.011
		U6 60G 5400RPM Seagate		56.02002.021
		Athena 20G 5400RPM Maxtor		56.02B32.131
		Romulus 40G 5400RPM Maxtor		56.02C10.071
		Snowmass 40G 7200RPM Seagate		KH.34001.001
		Snowmass 80G 7200RPM Seagate		KH.38001.001
<b>CD-ROM/CD-RW/DVD Drive</b>				
		CD-ROM 52x	CD ROM 52x AOPEN CD-952E	91.39D37.227
		CD-ROM 52x	CD ROM 52x BENQ 652A-049	56.10290.011
		24x10x40	CRW AOPEN 2440	91.60D37.007
		16x/40x	DVD PIONEER-117RD	56.22012.001
<b>Cables</b>				
	NS	AUDIO CABLE 4PIN 2C 520MM		50.A33V5.006
	NS	IDE Cable 40-pin		50.A33V5.002
	NS	USB CABLE 10PIN 260MM		50.A33V5.007



Picture	No.	Partname	Description	Part No.
	NS	IDE Cable 80-pin		50.A33V5.003
	8	FDD CABLE 34/34PIN 280MM		50.A33V5.004
	1-11	TURBO LED CABLE 2PIN 500MM		50.A33V5.001
	1-10	CD-IN CABLE 400MM		50.A33V5.008
	1-9	POWER SW/HDD & POWER LED		50.A33V5.005
Main Board				
	NS	MAINBOARD/J86M	J86M	MB.PSD05.002
	NS	Fansink for P4-478 pin CPU for minitower H34A housing		90.00028.002
	NS	Retention Module for 90.00028.002 fansink		60.37P01.001
CPU				

Picture	No.	Partname	Description	Part No.
	NS	Willamette 1.7G Socket 478	Willamette 1.7Ghz/400FSB	01.WILAM.1GV
		Willamette 1.8G Socket 478	Willamette 1.8Ghz/400FSB	01.WILAM.1GW
		Willamette 1.9G Socket 478	Willamette 1.9Ghz/400FSB	01.WILAM.1GK
		Willamette 2.0G Socket 478	Willamette 2.0Ghz/400FSB	01.WILAM.2G0
		Northwood 2.0G Socket 478	Northwood 2.0Ghz/512k/400FSB	01.NORTH.2G0
		Northwood 2.2G Socket 478	Northwood 2.2Ghz/512k/400FSB	01.NORTH.2G2
		Northwood 2.4G Socket 478	Northwood 2.4Ghz/512k/400FSB	01.NORTH.2G4
Memory				
	NS	DDR 266 128MB 0.18u 16Mx8x8 CL2.5	128MB DDR266 MICRON MT8VDDT1664AG-256A1	72.81664.L09
		DDR 266 256MB 0.18u 16Mx8x16 CL2.5	256MB DDR266 MICRON MT16VDDT3264AG-256A1	72.16326.L07
		DDR 266 256MB 0.17u 32Mx8x8 CL2	256MB DDR266 INFINEON HYS64D32000GU-7-A	72.64320.L01
		DDR 266 512MB 0.17u 32Mx16 CL2	521MB DDR266 INFINEON HYS64D64020GU-7-A	72.64640.L01
		DDR 266 128MB 16M*8 CL2	DDR 266 128MB CL2 Nanya	KN.12803.001
		DDR 266 256MB 16M*8 CL2	DDR 266 256MB CL2 Nanya	KN.25603.001
		DIS Battery/Lithium, B- CR2032-P/3V/220mAh, DIP/20		23.A33V5.001
		Flash ROM		72.A33V5.001

Picture	No.	Partname	Description	Part No.
<b>Boards</b>				
	NS	DAUGHTER BOARD		54.A33V5.001
	NS	VGA CARD		54.02001.061
	NS	1394 CARD		IF.13901.002
	NS	MODEM CARD V92 56K HSFI LB		54.09011.551
				54.09262.171
<b>Power Supply</b>				
	2	POWER SUPPLY 160W FSP160-60SAV NOPFC		56.04180.001
<b>Foot Stand</b>				
	7	FOOT STAND		60.A33V5.004
<b>Case/Cover/Bracket assembly</b>				
	1-1	HDD BRACKET		33.A33V5.001
	1-7	LOWER CASE		60.A33V5.005
	1-6	UPPER CASE		30.A33V5.001

Picture	No.	Partname	Description	Part No.
	NS	FRONT PANEL	ASSY FRONT BEZEL VT3200 H34	60.A33V5.002
	1-4	ROTATE BRACKET	ASSEMBLY ROTATE BRACKET H34A	60.A33V5.003
	1-5	I/O BRACKET	ASSEMBLY IO BRACKET(S81M)H34A	60.A33V5.001
		USB EMI COVER		34.A33V5.001
		SOFT MOUNT FOR HDD		42.A33V5.001
Screws				
	NS	SCREWS	SCREWS FOR USB BOARD/HDD BRACKET/MB	34.A33V5.001
	NS	SCREWS	SCREWS FOR FDD	34.A33V5.002
	NS	SCREWS	SCREWS FOR HDD	86.A33V5.001
	NS	SCREWS	SCREWS FOR SLOT/SPS	86.A33V5.002



## Model Definition and Configuration

---

The Acer Aspire 3300S Model No. Define:

1. Trade Mark:

The Acer logo, consisting of the word "acer" in a bold, italicized, lowercase sans-serif font.

2. Brand Name: Acer
3. Product Name: Acer Aspire 3300S



## Test Compatible Components

---

This computer's compatibility is tested and verified by Acer's internal testing department. All of its system functions are tested under Windows XP.

Refer to the following lists for components, adapter cards, and peripherals which have passed these tests. Regarding configuration, combination and test procedures, please refer to the Aspire 3300S Compatibility Test Report released by the Acer Desktop System Testing Department.



# Microsoft Windows XP Environment Test

Item	Specifications
AGP VGA Card	ASUS AGP-V7700Deluxe (GeForce 2 GTS) ASUS V8200 (GeForce 3) ELSA Gladiac 511 (GeForce 2 MX400) ELSA Gladiac 920 (Nvidia GeForce 3) Leadtek Winfast (GeForce 2 MX DH Pro) Matrox Millennium G550 (G55+MDHA32DB) MICRO-STAR MS-8851 (Nvidia GeForce 3 Ti 200) MICRO-STAR MS-8854 (Nvidia GeForce 3 Ti 500) MICRO-STAR MS-8836 (Nvidia GeForce 4 mx 460)
Network Card	3COM 3C905C-TXM D-Link DFE-530TX Intel Pro/100 S Desktop Adapter (82550)
IDE Hard Disk Drive	Fujitsu MPG3409AT-EF ATA (40G) IBM IC35L060AVER07-0 (61.5G) Maxtor DiamondMax 54098H8 (40.9G) Quantum Fireball Plus AS40000AT (40G) Quantum Fireball Plus AS6000AT (60G) Seagate Barracuda ATA III ST340824A (40G) Seagate Barracuda ATA VI T380021A (80G) WD Caviar WD400BB (40G) WD Caviar WD800BB (80G) WD Caviar WD1000BB (100G)
Memory	PC2100 DDR RAM SEC (KingMax) K4H280838B-TCBO 128MB Nanya NT5DS16M8AT-7K 128MB Nanya NT5DS16M8AT-75B 128MB Hyundai (TwinMOS) HY5DU28822T-H 128MB WinBond W942516AH-7 128MB Mosel V58C2128804SAT75 128MB Micron MT46V16M8TG-75 128MB Micron MT46V16M16TG-75B 128MB Micron MT46V16M8TG-75A 256MB Nanya NT5DS16M8AT-7K 256MB IBM (Apacer) N612804GT3B-7N 256MB Toshiba TC59WM807BFT-70 256MB Infineon HYB25D256800T-7 256MB Mosel V58C2128804SAT75 256MB PSC Mira PS256D30TP-75 256MB Infineon HYB25D256800AT-7A 512MB PC2700 DDR RAM Micron MT46V16M8TG-6 128MB SEC K4H280838C-TCB3 128MB Micron MT46V16M8TG-6 256MB Nanya NT5DS16M8AT-6K 256MB Winbond W942508AH-6 256MB SEC K4H560838C-TCB3 256MB SEC K4H560838C-TCB3 512MB

Item	Specifications
Floppy Disk Drive	EPSON SMD-1300 1.44MB NEC FD1231H 1.44MB TEAC FD235HF 1.44MB SONY MPF920-E/161 1.44MB Panasonic JU-257A606P 1.44MB Mitsumi D353M3 1.44MB Panasonic JU-811T012 ZIP Drive 100MB Panasonic LS-120 (LKM F934-1) 120MB Iomega Z100ATAPI ZIP 100MB
Sound Card	Creative Sound Blaster Live! (CT4620) Creative Sound Blaster 5.1 (SB0060) Creative Sound PCI 128 Digital (CT4750) Creative Sound Vibra 128 (CT4810) Mediatek SY-P1 Aureal AU8820 Mediatek SY-61X Forte Media FM801-AU
CD/DVD ROM Drive	CDROM TEAC CD-540E 40x Acer CD-650P 50x AOpen CD-952E/TKU 52x Micro-Star MS-8152 52x SONY CDU5211 52x LITE-ON LTN-526 52x Creative CD5222E YAMAHA BCD F563E 52x BTC BCD-G621D 56x DVDROM Acer DVP1640A2 16x AOpen DVD1648 16x ASUS DVD-E16 16x Lite-On LTD-163 16x Pioneer DVD-115 16x Pioneer DVD-116 16x Sony DDU1621 16x
Mouse	Logitech MouseMan Logitech M-U69 Mouse Logitech M-S61 Mouse Logitech Cordless Freedom Logitech M-CV46 Side-Button Logitech Mouse Man Wheel Logitech Cordless Freedom Optical Microsoft IntelliMouse Optical Microsoft IntelliMouse Microsoft IntelliMouse Explorer Mitsumi ECM-S3902
Keyboard	AOpen KB-2000 Keyboard Acer Accufel Keyboard (6311-TA) BTC Desktop Keyboard 5198 Microsoft Natural Keyboard Pro Logitech Cordless Freedom Logitech Deluxe 104 (SK-750) Logitech Cordless Freedom Optical
<b>USB</b>	

Item	Specifications
Keyboard	Microsoft Natural Keyboard Pro
	BTC Keyboard 5200 TU
Mouse	Logitech M-UB48
	Logitech Ifeel MouseMan M-UM53B
GamePad	Microsoft Side Winder FreeStyle Pro
Joystick	Logitech Wingman Force 3D
	Logitech Wingman Strike
Camera	Logitech Quick WEB V-UD10
	Logitech Cam Pro 3000 V-UF6
Speaker	Microsoft Digital Sound System 80
Scanner	EPSON Expression 1600 Scanner
	HP Scanjet 4400c
Printer	Epson Stulus Photo 890
	HP Deskjet 1220C
Floppy	Iomega Z100USB ZIP
	Iomega 250USB ZIP
	Data FAB USB-SLIM Floppy
Hard Disk Cable	Fata FAB MD2(E)-USB (2.5"Hard Disk)
	Gene Link GL620USB (PC to PC)
CD RW	YAMAHA CRW3200E-VK
	SONY CRX175A
CPU	Pentium 4 1.5G
	Pentium 4 1.6G
	Pentium 4 1.7G
	Pentium 4 1.8G
	Pentium 4 1.9G
	Pentium 4 2.0G
	Pentium 4 2.2G

## Online Support Information

---

This section describes online technical support services available to help you repair your Acer Systems.

If you are a distributor, dealer, ASP or TPM, please refer your technical queries to your local Acer branch office. Acer Branch Offices and Regional Business Units may access our website. However some information sources will require a user i.d. and password. These can be obtained directly from Acer CSD Taiwan.

Acer's Website offers you convenient and valuable support resources whenever you need them.

In the Technical Information section you can download information on all of Acer's Notebook, Desktop and Server models including:

- Service guides
- User's manuals
- Training materials
- Main manuals
- Bios updates
- Software utilities
- Spare parts lists
- Chips
- TABs (Technical Announcement Bulletin)

For these purposes, we have included an Acrobat File to facilitate the problem-free downloading of our technical material.

Also contained on this website are:

- Detailed information on Acer's International Traveler's Warranty (ITW)
- Returned material authorization procedures
- An overview of all the support services we offer, accompanied by a list of telephone, fax and email contacts for all your technical queries.

We are always looking for ways to optimize and improve our services, so if you have any suggestions or comments, please do not hesitate to communicate these to us.



---

## A

Advanced Options 43

    PnP/PCI 44

Assignment Map 18

Audio

    controller 16

Audio Interface 16

## B

BIOS Setup 24

    Entering Setup 25

    Setup Utility 25

    System Information 26

BIOS Utility 45

    Advanced Options 43

    Boot Options 40

    Date 41

    Disk Drives 29

    Onboard Peripherals 32

    PnP/PCI Options 44

    Power Management 35

    Product Information 27

    System Security 42

    Time 41

Block Diagram 8, 9

Boot Options 40

## C

Cache Memory 15

    size 15

    speed 15

Chipset Settings 45

    System Utilities 45

Chipsets 20

CMOS Setup 24

Compatibility Test 98

Connectors 76

    description 77

controllers 20

    audio 16

    serial port 17

Current 21

## D

Date 41

Device Standby Mode 22

Disk Drives 29

---

floppy disk drives A/B 29  
IDE primary channel master 29  
IDE primary channel slave 29  
IDE secondary channel master 30  
IDE secondary channel slave 30

DRQ Assignment Map 20

## E

ECP 17

Environmental Requirements 20

EPP 17

## F

features 2

connectivity 2  
design 3  
ergonomics 3  
Multimedia 2  
Performance 2

Floppy disk drive Interface 16

Frequency 21

front panel 4

FRU 88

## G

Global Standby Mode 22

## H

Hardware Specifications and Configurations 14

Housing 51

Opening the 51

Humidity 20

## I

I/O Address Map 19

IDE Channel

Device Type 31

IDE Interface 16

IDE Primary/Secondary Channel Master/Slave 31

IDSEL 18

Interface

audio 16  
IDE 16  
Video 15

IRQ Assignment Map 19

## J

---

Jumper and Connector Information 76

Jumpers 76

## K

keyboard 12

## M

Machine Disassembly 48

cover 51

Housing Cover 51

Main board 77

Main Board Layout 9

Mechanical Specifications 21

Memory

removing 57

size 15

system 15

Memory Address Map 18

Microsoft DOS V6.22 Environment Test 98

Model Definition 96

Modem 17

data 17

fax 17

voice 17

MPU-401 16

## O

Onboard Peripherals 32

IRQ 32

Online Support Information 102

Overview 1

## P

Parallel Port 17

Password

setting 42

PCI INTx# 18

PCI Slot IRQ 18

POST 63

Power Management 35

IDE hard disk timer 38

modem ring indicator 39

modes 38

PCI Power Management 39

power switch > 4 seconds 39

Restart on AC/Power Failure 39

Sleep mode 39



---

system sleep timer 39  
system wake-up event 39

Power-On Self-Test (POST) 63

Product Information 27

BIOS Release Date 28  
main board ID 28  
main board S/N 28  
product name 28  
SMBIOS version 28  
System BIOS ID 28  
system BIOS version 28  
system serial number 28

## R

Removal and Replacement 48

Replacement

Assembly, Machine 48

RIMM

Removing 57

RMA 88

Routing Map 18

## S

Security 42

Serial Port 17

socket

memory 15

Socket 370 14

Suspend Mode 22

Switching

Power Supply 21  
Power Supply 102W 21

Symptoms List

Audio 73  
CD/DVD-ROM Drive 72  
Diskette Drive 71  
Keyboard 74  
Memory 71  
Modem 73  
Monitor 73  
Other 74  
Parallel Port 74  
Power Supply 74  
Processor / Processor Fan 71  
Real-Time Clock 72  
Serial Port 74  
System Board 71  
Video 73

System Memory 57

System Specifications 1

design 3  
Features 2

System Utilities 24

---

Advanced Options 43  
Boot Options 40  
Date 41  
Disk Drives 29  
Onboard Peripherals 32  
PnP/PCI Options 44  
Power Management 35  
Product Information 27  
System Security 42  
Time 41

## **T**

Temperature 20  
Test Compatible Components 98  
Time 41  
Troubleshooting 62

## **U**

UART 17  
Undetermined Problems 75  
USB Port 17

## **V**

Vibration 20  
Voltage 21

## **W**

Weight 21  
Windows 98 SE Environment Test 99